

SM2A312FV

Photoelectric Sensor – Photoelectric Sensor for Glass Fibers

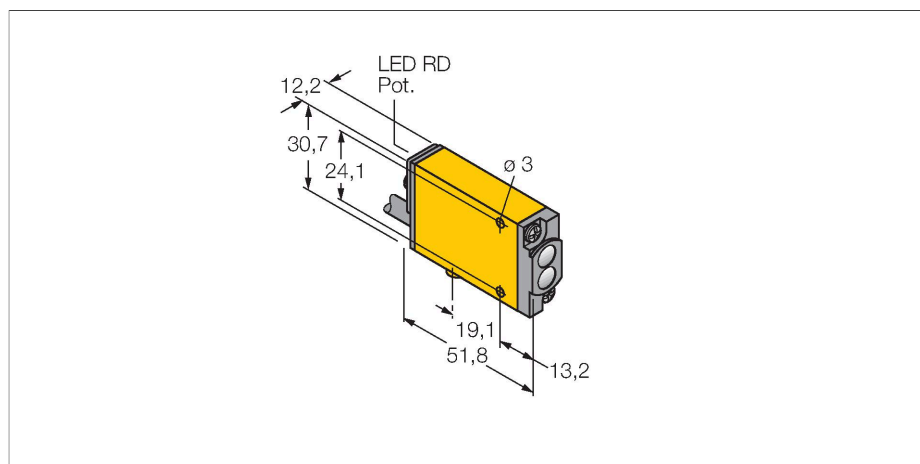

Features

- Cable, PVC, 2 m
- Protection class IP67
- Sensitivity adjusted via potentiometer
- Alignment indicator
- Operating voltage: 24...240 VAC
- Switching output, bipolar
- Light/dark operation

Wiring diagram

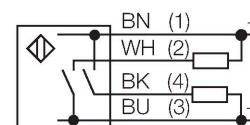

Technical data

Type	SM2A312FV
ID no.	3026863
Optical data	
Function	Photoelectric sensor for glass fibers
Fiber-optic type	glass
Light type	Red
Wavelength	650 nm
Electrical data	
Operating voltage	24...240 VAC
Output function	Relay output
Readiness delay	≤ 300 ms
Response time typical	< 8 ms
Setting option	Potentiometer
Mechanical data	
Design	Rectangular with thread, Mini Beam
Housing material	Plastic, Thermoplastic material, Yellow
Lens	plastic, Acrylic
Electrical connection	Cable, 2 m, PVC
Number of cores	2
Ambient temperature	-20...+70 °C
Relative humidity	0...90 %
Protection class	IP67
Special features	Wash down
Excess gain indication	LED
Tests/approvals	
Approvals	CE, cURus, CSA

Functional principle

Glass or plastic fibers are the optimum choice for high-temperature applications and limited spaces. Optical fibers transfer the light from the sensor to a remote object. Individual fibers are used for opposed sensing mode, whereas bifurcated fibers are suited for diffuse sensing mode.

Excess gain curve
Excess gain in relation to distance

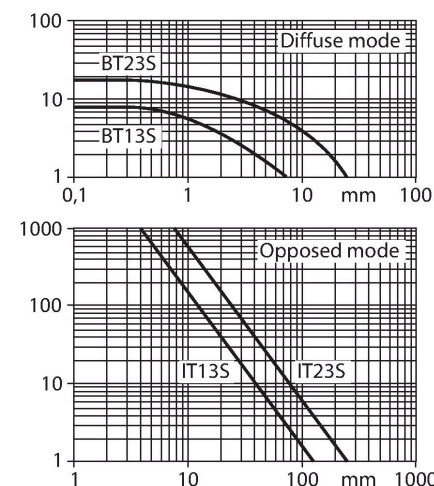

Accessories

SMB18A 3033200

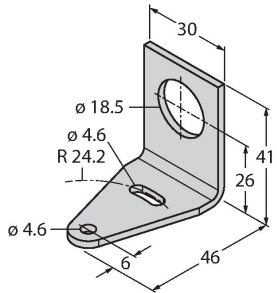

Mounting bracket, rectangular, stainless steel, for sensors with 18 mm thread

SMB18AFAM10 3012558

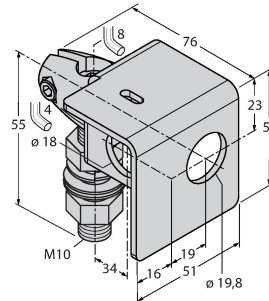

Mounting bracket, material VA 1.4401, for M10 x 1.5 thread, thread length 18 mm

SMB18SF 3052519

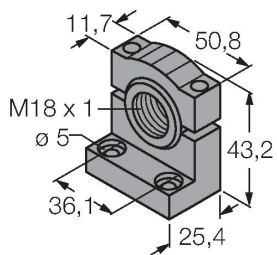

Mounting bracket, PBT black, for sensors with 18 mm thread, rotatable

SMB312B 3025519

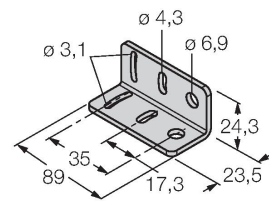

Mounting bracket, stainless steel, for MINI-BEAM NAMUR

SMB3018SC 3053952

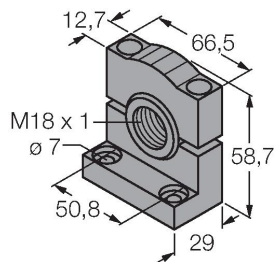

Mounting bracket, PTB black, for sensors with 18 mm thread

Accessories

Dimension drawing	Type	ID no.	
-------------------	------	--------	--

BT23S

3017276

Glass fiber, sensing mode: Diffuse mode, threaded sleeve (brass), bundle diameter 3.2 mm, flexible stainless steel jacket, ambient temperatures -140... +250 °C

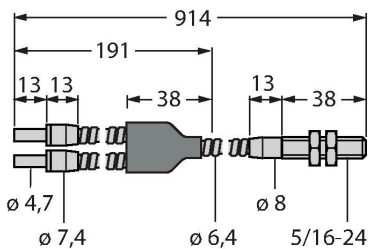

Dimension drawing	Type	ID no.	
	IT23S	3017355	Glass fiber, sensing mode: Opposed mode, threaded sleeve (brass), bundle diameter 3.2 mm, flexible stainless steel jacket, ambient temperatures -140...+250 °C

