

# M18SN6FF50Q

## Photoelectric Sensor – Diffuse Mode Sensor with Fixed-Field Background Suppression

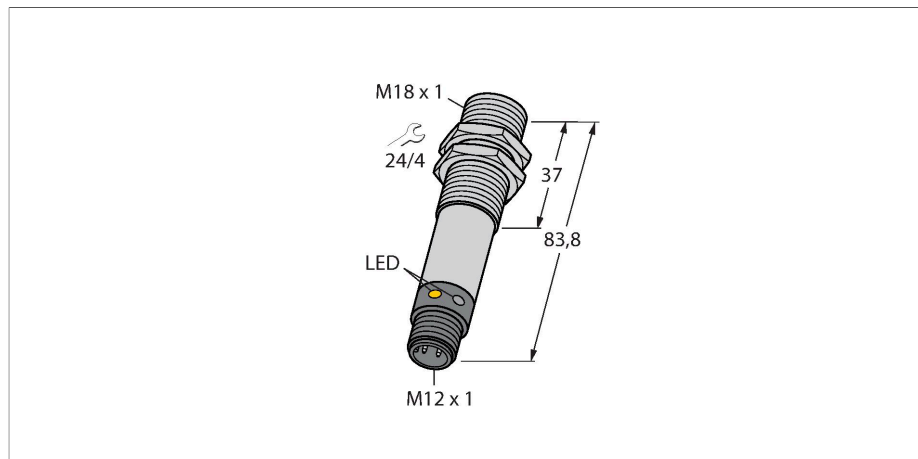

### Features

- M12 × 1 male connector, 4-pin
- Protection classes IP67/IP69K
- Ambient temperature: -40 °C...+70 °C
- Metal housing
- Male M12 × 1

### Wiring diagram

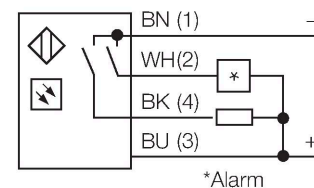
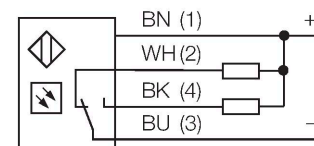

### Functional principle

The emitter and receiver are incorporated in a single housing. The light reflection of the target is detected and triggers the sensor to switch. Thus the switching distance largely depends on the reflectivity of the target.

Excess gain curve

Excess gain in relation to the distance

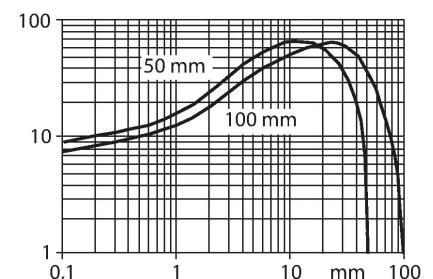

### Technical data

Type	M18SN6FF50Q
ID no.	3048669
<b>Optical data</b>	
Function	Proximity switch
Operating mode	Background suppression, non-adjustable
Light type	IR
Wavelength	880 nm
Range	0...50 mm
<b>Electrical data</b>	
Operating voltage	10...30 VDC
No-load current	≤ 35 mA
Short-circuit protection	yes / Cyclic
Reverse polarity protection	yes
Output function	Connection programmable, NPN
Switching frequency	≤ 160 Hz
Readiness delay	≤ 100 ms
Response time typical	< 3 ms
Overcurrent release	> 220 mA
<b>Mechanical data</b>	
Design	Threaded barrel, M18
Dimensions	Ø 18 x 83.8 mm
Housing material	Metal, Stainless steel
Lens	plastic, Acrylic
Electrical connection	Connectors, M12 × 1, PVC
Number of cores	4
Ambient temperature	-40...+70 °C

## Technical data

Protection class	IP69
Special features	Chemical-resistant Encapsulated Wash down Resistant to chemicals
Power-on indication	LED, Green
Switching state	LED, Yellow
Error indication	LED, green, Flashing
Excess gain indication	LED
Alarm display	LED yellow Flashing
<b>Tests/approvals</b>	
MTTF	448 years acc. to SN 29500 (Ed. 99) 40 °C
Approvals	CE

## Accessories

SMB18A

3033200

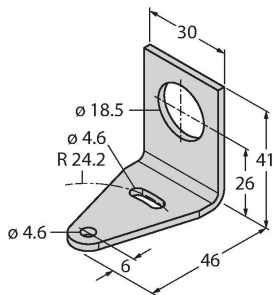

Mounting bracket, rectangular, stainless steel, for sensors with 18 mm thread

SMB18AFAM10

3012558

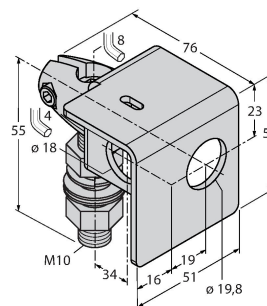

Mounting bracket, material VA 1.4401, for M10 x 1.5 thread, thread length 18 mm

SMB3018SC

3053952

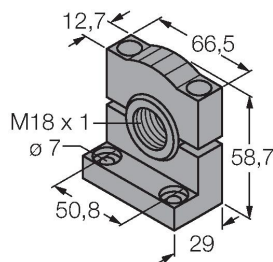

Mounting bracket, PTB black, for sensors with 18 mm thread

SMBAMS18P

3073134

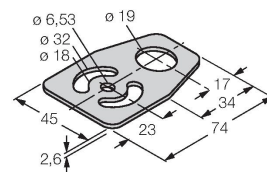

Mounting bracket, stainless steel, for sensors with 18 mm thread

## Accessories

Dimension drawing	Type	ID no.	
	RKC4.4T-2/TEL	6625013	Connection cable, female M12, straight, 4-pin, cable length: 2 m, sheath material: PVC, black; cULus approval; other cable lengths and qualities available, see <a href="http://www.turck.com">www.turck.com</a>
	WKC4.4T-2/TEL	6625025	Connection cable, female M12, angled, 4-pin, cable length: 2 m, sheath material: PVC, black; cULus approval; other cable lengths and qualities available, see <a href="http://www.turck.com">www.turck.com</a>