

PT25R-1008-U1-H1143/X

Pressure Transmitter – With Voltage Output (3-Wire)

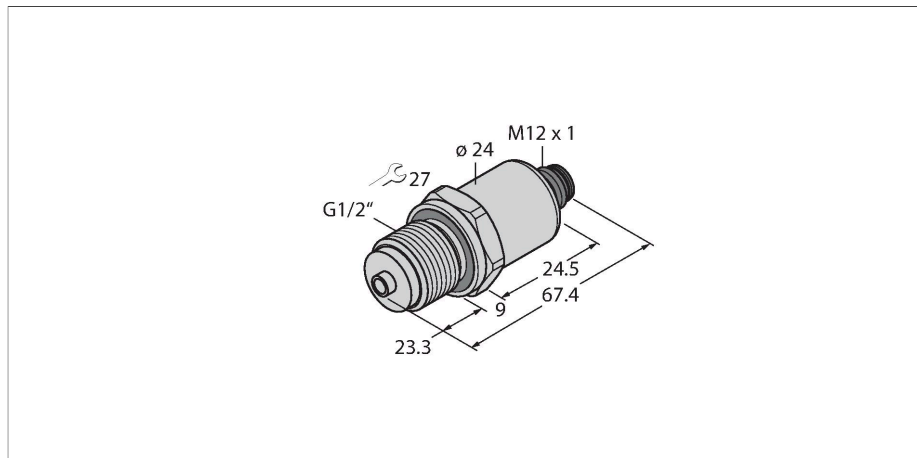

Features

- Ceramic measuring cell
- Compact and robust design
- Excellent EMC properties
- Pressure range 0...25 bar rel.
- Pressure tip orifice
- 12...33 VDC
- Analog output 0...10 V
- Process connection G1/2" male thread, back sealing and manometer (combi)
- Connector device, M12 × 1

Wiring diagram



Technical data

Type	PT25R-1008-U1-H1143/X
ID	6836407
Pressure range	
Pressure type	Relative pressure
Pressure range	0...25 bar
	0...362.59 psi
	0...2.5 MPa
Admissible overpressure	≤ 75 bar
Burst pressure	≥ 75 bar
Response time	< 2 ms, typ. 1 ms
Long-term stability	0.25 % FS, according to IEC EN 60770-1
Power supply	
Operating voltage	12...33 VDC
Current consumption	≤ 7 mA
Short-circuit/reverse polarity protection	yes / yes
Protection type and class	IP67 / III
Insulation voltage	750 VDC
Outputs	
Output 1	Analog output
Output function	Analog output voltage
Analog output	
Voltage output	0...10 V
Load	≤ 100 nF / >10 kΩ
Resolution	<± 0.1 % FS
Accuracy LHR	±0.3 % FS (typical; max. ±0.5 % FS)

Functional principle

The pressure sensors in the PT...-1000 product series operate with a ceramic measuring cell in various pressure ranges of up to -1...60 bar in 2-, 3- or even 4-wire technology. Depending on the sensor variant, the processed signal is available as an analog output signal (4...20 mA, 0...10 V, 0...5 V, 1...6 V, ratiometric) or as a digital IO-Link process parameter. The IO-Link sensor variants also have two independently configurable switching outputs.

In addition to the standard variants, there are special sensors for uses such as ATEX areas or for oxygen applications.

A wide range of process connections and electrical connections offer a high degree of flexibility in a wide range of applications.

Technical data

Temperature behaviour	
Medium temperature	-40...+125 °C
Temperature coefficient	± 0.2 % of full scale/10 K
Environmental conditions	
Ambient temperature	-30...+85 °C
Storage temperature	-50...+100 °C
Vibration resistance	20 g, 15...2000 Hz, 15...25 Hz with amplitude ± 15 mm, 1 octave/minute in all 3 directions, 50 continuous loads, acc. to IEC 68-2-6
Shock resistance	100 g, 11 ms, half sinusoidal curve, all 6 directions, free fall from 1 m onto concrete (6x) acc. to IEC 68-2-27
Mechanical data	
Housing material	Stainless-steel/Plastic, 1.4404 (AISI 316L)/polyarylamide 50 % GF UL 94 V-0
Pressure connection material	Stainless steel 1.4404 (AISI 316L)
Pressure transducer material	Ceramic Al ₂ O ₃
Sealing material	FPM spez.
Process connection	G 1/2" male thread, rear sealing and manometer (combi)
Wrench size pressure connection / coupling nut	27
Electrical connection	Connector, M12 × 1
Max. tightening torque of housing nut	30 Nm
Reference conditions acc. to IEC 61298-1	
Temperature	15...+25 °C
Atmospheric pressure	860...1060 hPa abs.
Humidity	45...75 % rel.
Auxiliary power	24 VDC
Tests/approvals	
Approvals	cULus
UL registration number	E302799
MTTF	1238 years acc. to SN 29500 (Ed. 99) 40 °C
Included in delivery	Profile seal FKM special (1 pc)