

# QS30LDQPMA

## Photoelectric Sensor – Diffuse Mode Sensor

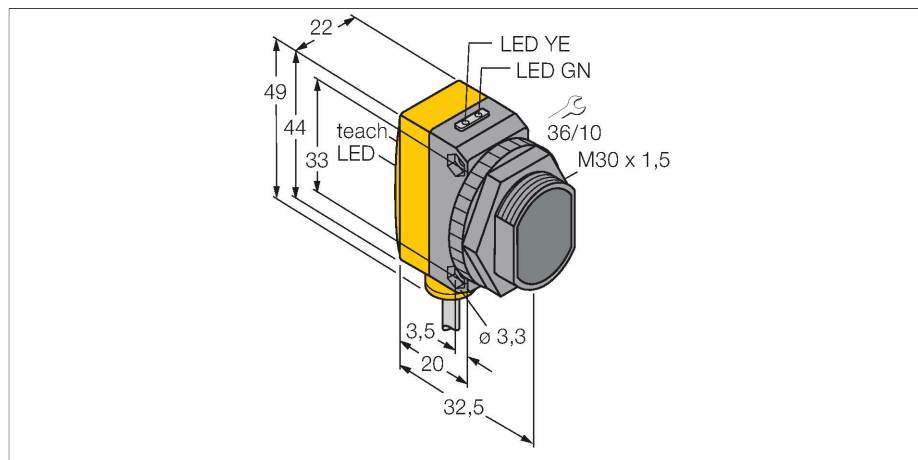

### Technical data

Type	QS30LDQPMA
ID no.	3072100
<b>Optical data</b>	
Function	Proximity switch
Operating mode	Diffuse
Light type	Red
Wavelength	650 nm
Laser class	▲ 2
Beam diameter	2 mm
Range	0...400 mm
<b>Electrical data</b>	
Operating voltage	10...30 VDC
Residual ripple	< 10 % U <sub>ss</sub>
DC rated operational current	≤ 150 mA
No-load current	≤ 35 mA
Short-circuit protection	yes
Reverse polarity protection	yes
Output function	NO contact, PNP/NPN
Switching frequency	≤ 1000 Hz
Readiness delay	≤ 1 s
Readiness delay	≤ 1000 ms
Response time typical	< 0.5 ms
Setting option	Push Button Remote Teach
<b>Mechanical data</b>	
Design	Rectangular with thread, QS30
Dimensions	Ø 30 x 35 x 22 x 49 mm

### Features

- Cable with male end M12 × 1, 5-pin, PUR, 150 mm
- Protection class IP67
- LED all-round visible
- Teach button
- 8-segment bargraph
- Operating voltage: 10...30 VDC
- Switching output, bipolar
- Light or dark operation

### Wiring diagram

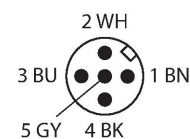
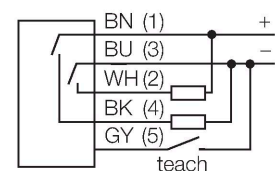

### Functional principle

The emitter and receiver are incorporated in the same housing. The light reflection of the target is detected and causes the sensor to switch. Thus the switching distance largely depends on the reflectivity of the target.

Excess gain curve

Excess gain in relation to the distance

## Technical data

Housing material	Plastic, Thermoplastic material, Yellow
Lens	plastic, Acrylic
Electrical connection	Cable with connector, M12 × 1, 0.15 m, PUR
Number of cores	5
Ambient temperature	-10...+50 °C
Protection class	IP67
Special features	keep/defer
Power-on indication	LED, Green
Switching state	LED, Yellow
Error indication	LED, green, Flashing
Excess gain indication	LED, red, flashing
<b>Tests/approvals</b>	
MTTF	28 years acc. to SN 29500 (Ed. 99) 40 °C
Approvals	CE

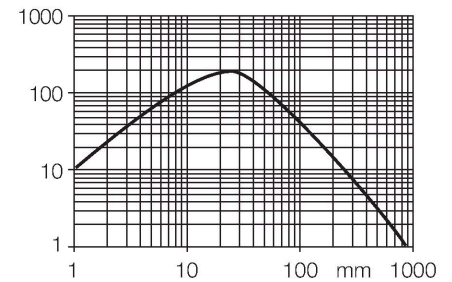

## Accessories

SMB30A

3032723

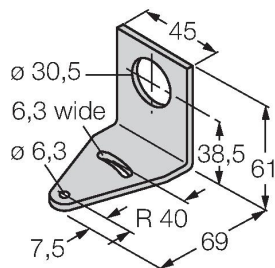

Mounting bracket, rectangular, stainless steel, for sensors with 30mm thread

SMBQS30L

3002809

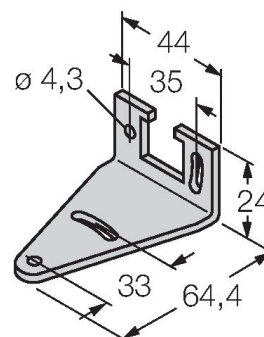

Mounting bracket, stainless steel, for QS30 series

SMB30MM

3027162

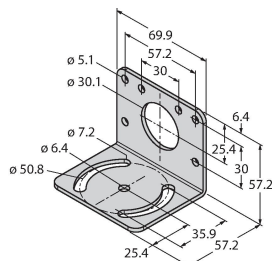

Mounting bracket, rectangular, stainless steel, for sensors with 30 mm thread, wide holes for accurate alignment

SMB30SC

3052521

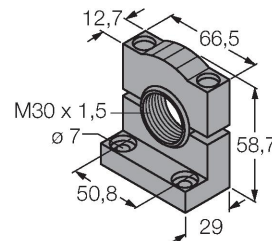

Mounting bracket, PBT black, for sensors with 30 mm thread, rotatable

## Accessories

Dimension drawing	Type	ID no.	
	WKC4.5T-2/TEL	6625028	Connection cable, female M12, angled, 5-pin, cable length: 2 m, sheath material: PVC, black; cULus approval; other cable lengths and qualities available, see <a href="http://www.turck.com">www.turck.com</a>
	RKC4.5T-2/TEL	6625016	Connection cable, female M12, straight, 5-pin, cable length: 2 m, sheath material: PVC, black; cULus approval; other cable lengths and qualities available, see <a href="http://www.turck.com">www.turck.com</a>