

# Q20PFF150Q7

## Photoelectric Sensor – Diffuse Mode Sensor with Fixed-Field Background Suppression

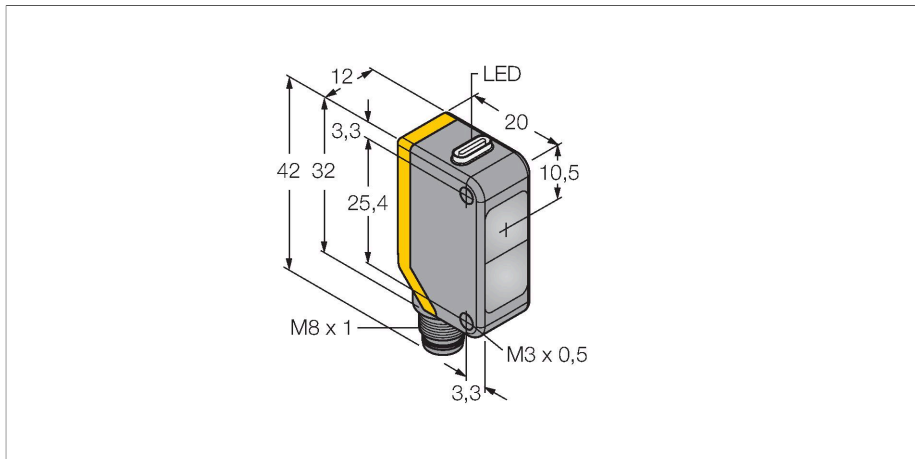

### Technical data

Type	Q20PFF150Q7
ID no.	3078156
<b>Optical data</b>	
Function	Proximity switch
Operating mode	Background suppression, non-adjustable
Light type	Red
Wavelength	655 nm
Range	0...150 mm
<b>Electrical data</b>	
Operating voltage	10...30 VDC
Residual ripple	< 10 % U <sub>ss</sub>
DC rated operational current	≤ 100 mA
No-load current	≤ 18 mA
Reverse polarity protection	yes
Output function	Complementary contact, PNP
Switching frequency	≤ 600 Hz
Readiness delay	≤ 100 ms
Response time typical	< 0.8 ms
<b>Mechanical data</b>	
Design	Rectangular, Q20
Dimensions	20 x 12 x 42 mm
Housing material	Plastic, Thermoplastic material
Lens	plastic, Acrylic
Electrical connection	Connectors, M8 × 1, PVC
Number of cores	4
Ambient temperature	-20...+60 °C

### Features

- Male M8 × 1; 4-pin
- Protection class IP67
- LED all-round visible
- Operating voltage: 10...30 VDC
- PNP switching output, changeover

### Wiring diagram

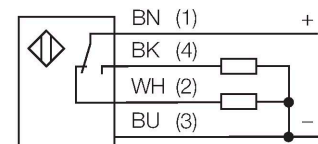

### Functional principle

Diffuse mode sensors with background suppression operate with a single emitter and several receiver elements. The target position and the photoelectric structure of the sensor determine which receiver element gets the most light. The sensor electronics determine whether the reflecting object is within or outside the measuring range. These sensors come with a fixed cut-off point.

Excess gain curve  
Excess gain in relation to the distance

## Technical data

Protection class	IP67
Power-on indication	LED, Green
Switching state	LED, Yellow
Error indication	LED, green, Flashing
Excess gain indication	LED, yellow, flashing
<b>Tests/approvals</b>	
Approvals	CE

## Excess Gain Curve

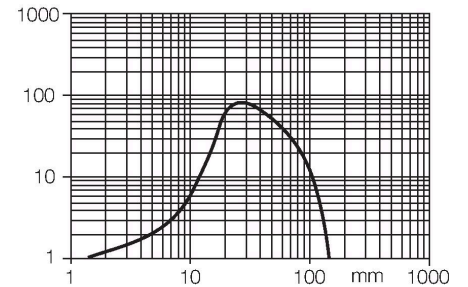

## Accessories

**SMBQ20H** 3079041

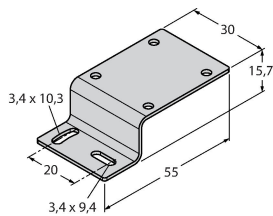

Mounting bracket, stainless steel, horizontally mounted, for Q20

**SMBQ20L** 3079040

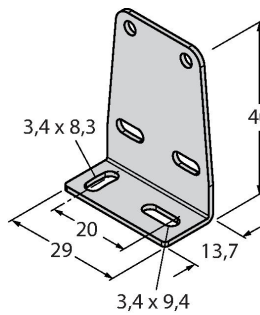

Mounting bracket, stainless steel, rectangular, for Q20

**SMBQ20LV** 3079042

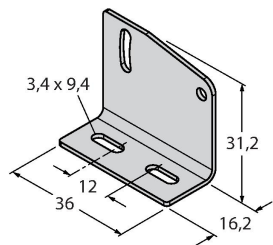

Mounting bracket, stainless steel, rectangular, for Q20

**SMBQ20U** 3079043

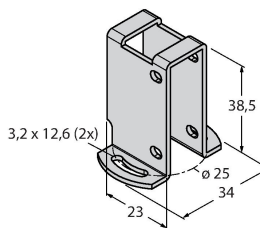

Protective housing, stainless steel, for Q20

## Accessories

**Dimension drawing** Type ID no.



PKW4M-2/TEL

6625067

Connection cable, female M8, angled, 4-pin, cable length: 2 m, sheath material: PVC, black; cULus approval; other cable lengths and qualities available, see [www.turck.com](http://www.turck.com)



PKG4M-2/TEL

6625061

Connection cable, female M8, straight, 4-pin, cable length: 2 m, sheath material: PVC, black; cULus approval; other cable lengths and qualities available, see [www.turck.com](http://www.turck.com)