

WLS28-2XBR-1130XQ

Work Light – Linear Light

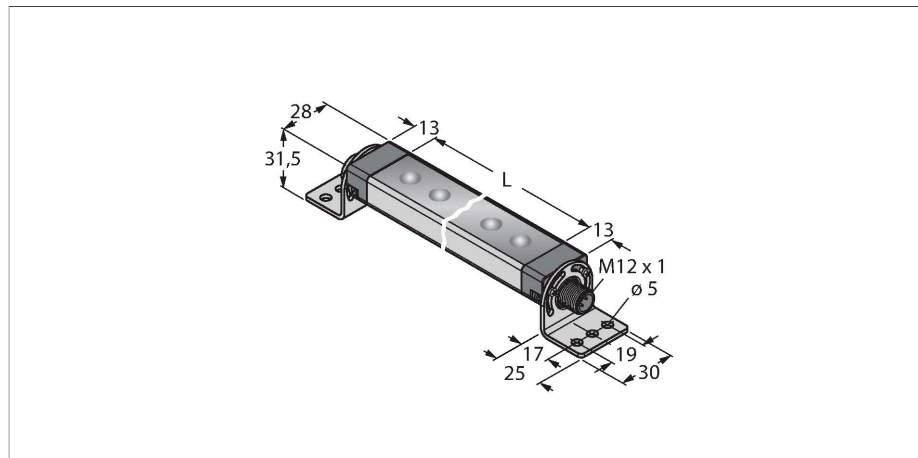

Features

- Color 1: blue (100% light intensity)
- Color 2: red (100% light intensity)
- 2-color linear light
- M12 x 1 male, straight, 4-pin
- SMBWLS28RA mounting bracket included in delivery

Wiring diagram

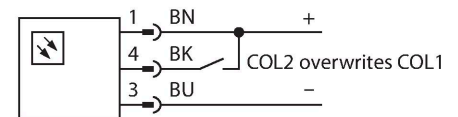

Technical data

Type	WLS28-2XBR-1130XQ
ID	3804785
Signal and display data	
Purpose	LED work light
Function	Linear light
Light type	Blue Red
Aperture angle degree	60 °
Beam angle	wide beam 40-80°
LED service life (L70)	50000 h
Dimmable	Yes
Features of color 1	Blue, Permanently on, 100 %, 320 lm
Features of color 2	Red, Permanently on, 100 %, 440 lm
Electrical data	
Operating voltage	12...30 VDC
DC rated operational current	≤ 3040 mA
Input power	36.48 W
Mechanical data	
Cascadable	No
Design	Rectangular, WLS28-2
Dimensions	1173 x 28 x 21 mm
Housing material	Metal, AL
Window material	Polycarbonate, clear
Electrical connection	Connector, M12 × 1, PVC
Number of cores	4
Ambient temperature	-40...+70 °C
Storage temperature	-40...+70 °C

Functional principle

The energy-efficient LED work lights are ideally suited for industrial applications. The color temperature is between 4,700 and 5,300 Kelvin (cool white). Depending on the model, the luminous flux is 475 or 1900 lumen. Some work lights are switched on/off via supply power (10...30 VDC) and some types by means of a button directly at the LED lamp. In addition, the LED can be switched to second color by activating a high signal on PIN 4, or for the variants with a switch by means of a further switch position. This additional color can be selected with either 100, 50 or 33% light intensity. Cascadable variants are also available. Variants with a clear or diffuse plastic windows, as well as with an aperture angle of 25°.

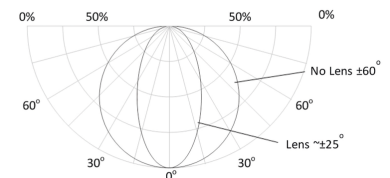

Technical data

Relative humidity	0...90 %
Protection class	IP50
Tests/approvals	
Approvals	CE, UL

Light Length	Typical Current			Max. Current
	12 VDC	24 VDC	30 VDC	A
145 mm	0.33 A	0.15 A	0.12 A	0.4
285 mm	0.66 A	0.30 A	0.24 A	0.8
430 mm	1.01 A	0.46 A	0.36 A	1.2
570 mm	1.36 A	0.61 A	0.48 A	1.6
710 mm	1.75 A	0.77 A	0.60 A	2.0
850 mm	2.13 A	0.92 A	0.73 A	2.4
990 mm	2.59 A	1.08 A	0.85 A	2.8
1130 mm	3.04 A	1.24 A	0.97 A	3.2

Accessories

SMBWLSMAG 3019574

Magnetic fixture for mounting work lights and sensors, 2 pieces

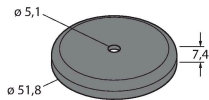

SMBWLS28RA 3015764

Mounting bracket, angled, metal, for WLS28 work lights, 5 mm drill holes, screw set included

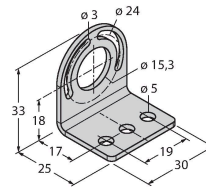

SMBWLS28SP 3088063

Snap bracket for mounting WLS28 work lights

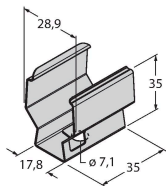

Accessories

Dimension drawing Type ID



RKC4.4T-2/TEL

6625013

Connection cable, M12 female connector, straight, 4-pin, cable length: 2 m, jacket material: PVC, black; cULus approval

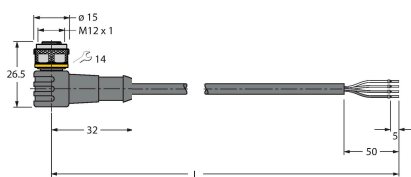

WKC4.4T-2/TEL

6625025

Connection cable, M12 female connector, angled, 4-pin, cable length: 2 m, jacket material: PVC, black; cULus approval