

# RSC4.4T-0.3/TXL

## Actuator and Sensor Cable, PUR – Connection Cable

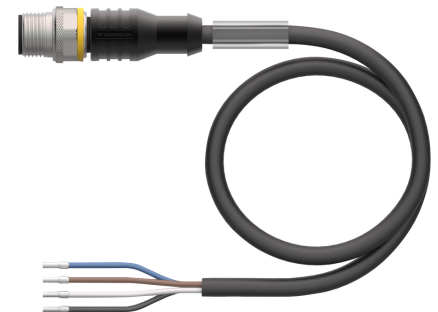
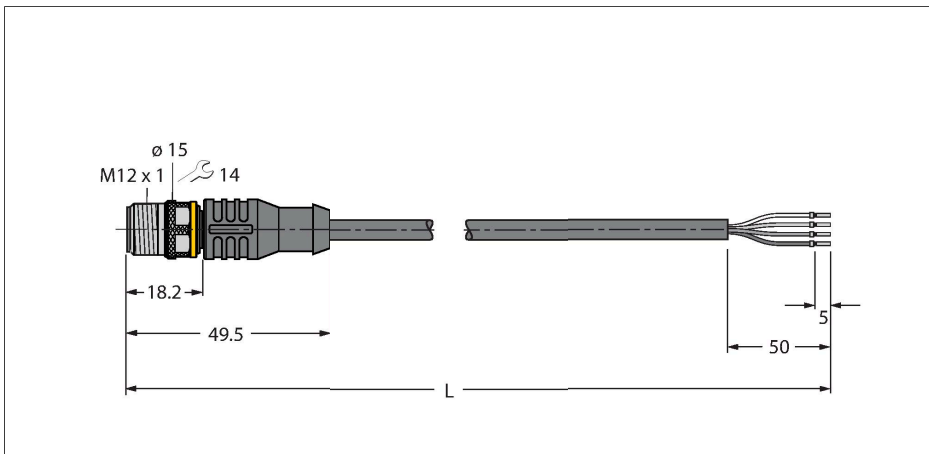

### Technical data

|   |  |
|---|--|
| Type                                      | RSC4.4T-0.3/TXL                        |
| ID  | 6628802                                |
| Connector A                               | Male, M12 × 1, Straight, A-coded       |
| Number of Pins                            | 4                                      |
| Contacts                                  | Brass, CuZn, Gold-plated               |
| Contact carriers                          | Plastic, TPU, Black                    |
| Connector body                            | Plastic, TPU, Black                    |
| Coupling nut/screw                        | Brass, CuZn, Nickel-plated             |
| Mechanical lifespan                       | > 100 Mating cycles                    |
| Pollution degree                          | 3                                      |
| Protection class                          | IP67, IP69K, Only in screwed condition |
| <b>Cable</b>                              |  |
| Cable diameter                            | Ø 4.5 mm ±0.20                         |
| Cable length                              | 0.3 m                                  |
| Cable jacket                              | PUR, Black                             |
| Core insulation                           | PP                                     |
| Core cross-section                        | 4 x 0.34 mm <sup>2</sup>               |
| Arrangement of strands                    | 42 x 0.1 mm                            |
| Core colors                               | BN, WH, BU, BK                         |
| <b>Electrical properties at +20 °C</b>    |  |
| Rated voltage                             | 250 V                                  |
| Test voltage                              | 2000 V                                 |
| Current                                   | 4 A                                    |
| Insulation resistance                     | > 30.5 MΩ/km                           |
| forward resistance                        | max. 57 Ω/km                           |
| <b>Mechanical and chemical properties</b> |  |
| Bending radius (stationary installation)  | ≥ 5 x Ø                                |

### Features



- Male M12, straight, 4-pin
- Jacket material: PUR
- Jacket color: black
- Suitable for drag chain use
- Resistant to chemicals, UV radiation and oils
- Flame retardant (FT2 acc. to UL 1581, IEC 60332-2-2)
- Resistant to welding sparks
- Free from halogen, silicone, PVC and LABS
- Particularly resistant to abrasion
- Protection class: IP67, IP69K
- Cable length: 0.3 m

### Cable Cross-Section



### Contact assignment

## Technical data

|   |                               |
|---|-------------------------------|
| Bending radius (flexible use)                   | $\geq 10 \times \varnothing$  |
| Bending cycles                                  | $\geq 5$ million              |
| Admissible acceleration                         | max. $5 \text{ m/s}^2$        |
| Admissible travel path, horizontal              | 5 m (at $5 \text{ m/s}^2$ )   |
| Admissible travel path, vertical                | 2 m (at $5 \text{ m/s}^2$ )   |
| Admissible traversing speed                     | 3.3 m/s                       |
| Torsional stress                                | $\pm 180^\circ/\text{m}$      |
| Ambient temperature range (stationary)          | $-50 \dots +80^\circ\text{C}$ |
| Ambient temperature range (In motion)           | $-25 \dots +80^\circ\text{C}$ |
| Ambient temperature during drag chain operation | $-25 \dots +60^\circ\text{C}$ |
| Approvals                                       | cULus                         |

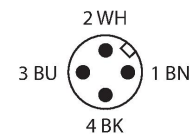

## Circuit Diagram

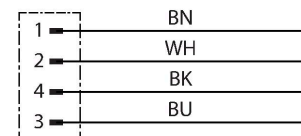

## Accessories

**TORQUE-WRENCH-SET-AS** 6936170

Torque wrench set; handles with adjustable torque 0.4-1.0 Nm, torque wrench for M8 (SW9), fork wrench for M12 (SW 14)

**BLANK-LABEL-FOR-CORDSETS-TEL-TXL** 6936206

Label for TEL and TXL cables, length: 18 mm, height: 4 mm, material: polycarbonate (PC), color: white, halogen-free and flame-retardant

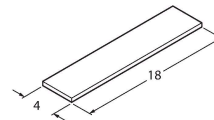

**HA8141-0** 6905407

Field-wireable female connector, M12 x 1, straight, 4-pin, insulation piercing connection, cable feedthrough 4.0 to 5.1 mm, core cross-section/terminal capacity 0.14 to 0.34 mm<sup>2</sup>, plastic housing, metal nut

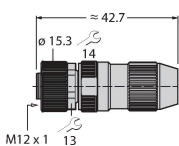

**HA8241-0** 6905401

Field-wireable female connector, M12 x 1, angled, 4-pin, insulation piercing connection, cable feedthrough 4.0 to 5.1 mm, core cross-section/terminal capacity 0.14 to 0.34 mm<sup>2</sup>, plastic housing, metal nut

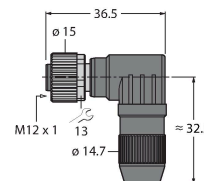

**B8141-0** 69049

Field-wireable female connector, M12 x 1, straight, 4-pin, screw terminal connection, cable feedthrough 4.0 to 6.0 mm, core cross-section/terminal capacity 0.14 to 0.75 mm<sup>2</sup>, plastic housing, plastic nut

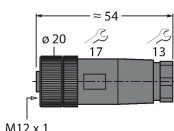

**B8241-0** 69048

Field-wireable female connector, M12 x 1, angled, 4-pin, screw terminal connection, cable feedthrough 4.0 to 6.0 mm, core cross-section/terminal capacity 0.14 to 0.75 mm<sup>2</sup>, plastic housing, plastic nut

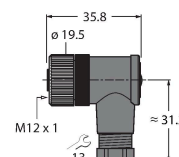

BM8141-0

6935145

Field-wireable female connector, M12 × 1, straight, 4-pin, screw terminal connection, cable feedthrough 4.0 to 6.0 mm, core cross-section/terminal capacity 0.25 to 0.75 mm<sup>2</sup>, plastic housing, metal nut

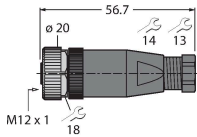

BM8241-0

6935889

Field-wireable female connector, M12 × 1, angled, 4-pin, screw terminal connection, cable feedthrough 4.0 to 6.0 mm, core cross-section/terminal capacity 0.25 to 0.75 mm<sup>2</sup>, plastic housing, metal nut

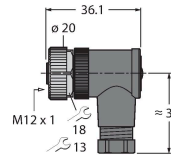

FW-ERKPM0426-SA-P-0408

100002047

Field-wireable female connector, M12 × 1, straight, 4-pin, push-in connection, cable feedthrough 4.0 to 8.0 mm, core cross-section/terminal capacity 0.14 to 0.75 mm<sup>2</sup>, plastic housing, metal coupling nut

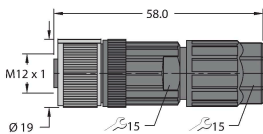

FW-ERKPM0416-SA-S-0408

100002283

Field-wireable female connector, M12 × 1, straight, 4-pin, screw terminal connection, cable feedthrough 4.0 to 8.0 mm, core cross-section/terminal capacity 0.25 to 1.5 mm<sup>2</sup>, plastic housing, metal nut

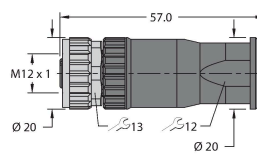

FW-EWKPM0416-SA-S-0408

100002286

Field-wireable female connector, M12 × 1, angled, 4-pin, screw terminal connection, cable feedthrough 4.0 to 8.0 mm, core cross-section/terminal capacity 0.25 to 1.5 mm<sup>2</sup>, plastic housing, metal nut

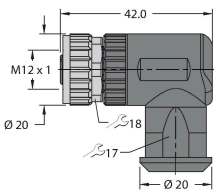

## Accessories

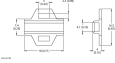
| Dimension drawing   | Type                  | ID        |  |
|---|-----------------------|-----------|--|
|  | LABEL-HOLDER-FLEX-PVC | 100048170 | PVC label holder for identification of extension cables (TEL/TXL product series); for cable diameters: min. 5 mm; dimensions 4 × 18 mm; delivery unit: 50 pcs. per package |