

QS18VP6LVQ

Photoelectric Sensor – Retroreflective Sensor

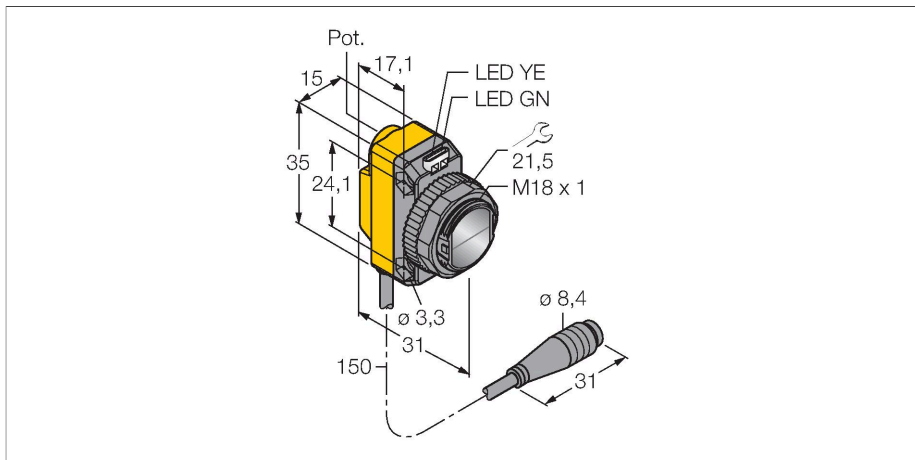

Technical data

Type	QS18VP6LVQ
ID no.	3061637
Optical data	
Function	Retroreflective Sensor
Operating mode	Unpolarized
Reflector included in delivery	no
Light type	Red
Wavelength	630 nm
Range	0...6500 mm
Electrical data	
Operating voltage	10...30 VDC
Residual ripple	< 10 % U _{ss}
DC rated operational current	≤ 100 mA
Short-circuit protection	yes
Reverse polarity protection	yes
Output function	NO/NC, PNP
Current output	100 mA
Switching frequency	≤ 800 Hz
Readiness delay	≤ 100 ms
Response time typical	< 0.6 ms
Setting option	Potentiometer
Mechanical data	
Design	Rectangular with thread, QS18
Dimensions	Ø 18 x 31 x 15 x 35 mm
Housing material	Plastic, ABS
Lens	plastic, Acrylic

Features

- Cable with male end, 4-pin, PVC, 150 mm, 8 mm
- Protection class IP67
- LED all-round visible
- Sensitivity adjusted via potentiometer
- Operating voltage: 10...30 VDC
- PNP switching output, changeover

Wiring diagram

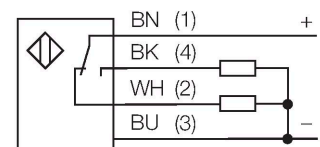

Functional principle

Retroreflective sensors have emitter and receiver circuitry incorporated in the same housing. The light beam of the emitter is directed towards a reflector which returns the light back to the receiver. A target is detected when it interrupts this beam. Retroreflective sensors feature some of the advantages of opposed mode sensors, such as good contrast and high excess gain. Furthermore, only one device has to be installed and wired. Devices without polarizing filter have a smaller sensing range and are more susceptible to disturbances caused by shiny objects.

Excess gain curve

Technical data

Electrical connection	Cable with connector, M8 × 1, 0.15 m, PVC
Number of cores	4
Ambient temperature	-20...+70 °C
Protection class	IP67
Power-on indication	LED, Green
Switching state	LED, Yellow
Error indication	LED, green, Flashing
Excess gain indication	LED, yellow, flashing
Tests/approvals	
Approvals	CE, cURus

Excess gain in relation to the distance (unpolarized)

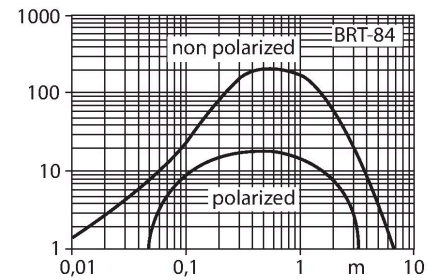

Accessories

SMB18A

3033200

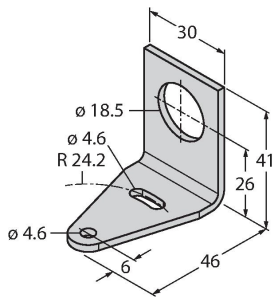

Mounting bracket, rectangular, stainless steel, for sensors with 18 mm thread

SMB18AFAM10

3012558

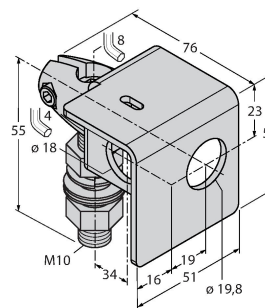

Mounting bracket, material VA 1.4401, for M10 x 1.5 thread, thread length 18 mm

SMBQS18A

3069721

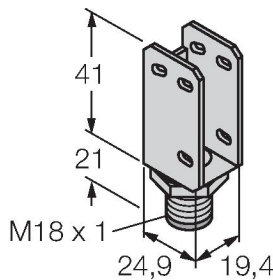

Mounting bracket, stainless steel, for 18 mm thread

SMB18SF

3052519

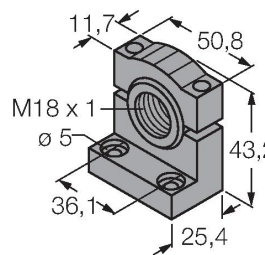

Mounting bracket, PBT black, for sensors with 18 mm thread, rotatable

Accessories

Dimension drawing	Type	ID no.	
	PKG4M-2/TEL	6625061	Connection cable, female M8, straight, 4-pin, cable length: 2 m, sheath material: PVC, black; cULus approval; other cable lengths and qualities available, see www.turck.com
	PKW4M-2/TEL	6625067	Connection cable, female M8, angled, 4-pin, cable length: 2 m, sheath material: PVC, black; cULus approval; other cable lengths and qualities available, see www.turck.com

Accessories

Dimension drawing	Type	ID no.	
	BRT-84	3058979	Round reflector, reflection coefficient 1.4, material acrylic, ambient temperature -20 ... +60 °C