

PKG4M-2/TFE

Food & Beverage Hygienic, PVC – Connection Cable

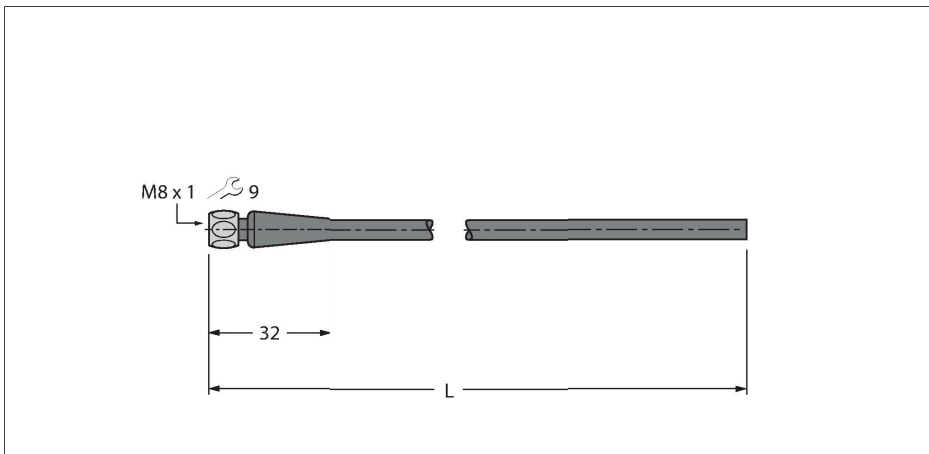

Technical data

Type	PKG4M-2/TFE
ID	6934450
Connector A	Female, M8 × 1, Straight
Number of Pins	4
Contacts	Brass, CuZn, Gold-plated
Contact carriers	Plastic, PP, Gray
Connector body	Plastic, PP, Gray
Coupling nut/screw	Stainless Steel, V4A
Seal	Plastic, FPM/FKM
Tightening torque (range)	0.5 ... 0.6 Nm (observe max. torque of mating connector!)
Mechanical lifespan	> 100 Mating cycles
Pollution degree	3
Protection class	IP65, IP67, IP68, IP69, Only in screwed condition
Cable	
Cable diameter	Ø 4.2 mm ±0.20
Cable length	2 m
Cable jacket	PVC, Gray
Core insulation	PVC
Core cross-section	4 x 0.25 mm ²
Arrangement of strands	14 x 0.15 mm
Core colors	BN, WH, BU, BK
Electrical properties at +20 °C	
Rated voltage	30 V
Test voltage	1500 V
Current	4 A

Features



- M8 female connector, straight, 4-pin
- Stainless steel coupling nut/screw
- Jacket material: PVC
- Jacket color: gray RAL 7040
- Resistant to acids and alkalis
- Resistant to oils and chemicals
- Flame-retardant acc. to DIN EN 60332 1-2, DIN EN 60332 2-2, VDE 0482 332-1-2, VDE 0482 332-2-2
- Approvals: Gost, Ecolab
- RoHS and REACH compliant
- Protection class IP67/IP69K
- Cable length: 2.0 m

Cable Cross-Section

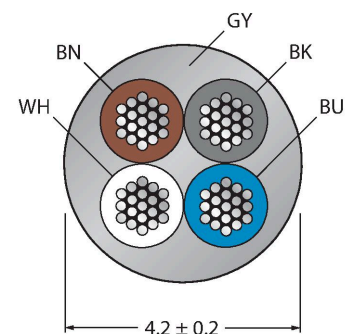

Contact assignment

Technical data

Insulation resistance $\geq 10^8 \Omega$

Mechanical and chemical properties

Bending radius (stationary installation) $\geq 3 \times \varnothing$

Bending radius (flexible use) $\geq 10 \times \varnothing$

Ambient temperature range (stationary) $-25 \dots +80 \text{ }^\circ\text{C}$

Ambient temperature range (In motion) $0 \dots +80 \text{ }^\circ\text{C}$

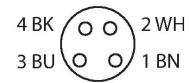

Circuit Diagram

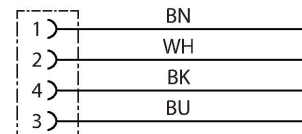

Accessories

TORQUE-WRENCH-SET-AS 6936170

Torque wrench set; handles with adjustable torque 0.4-1.0 Nm, torque wrench for M8 (SW9), fork wrench for M12 (SW 14)