

REM-103S6C-3C13S12M-H1181

Absolute Rotary Encoder - Multiturn

Industrial Line

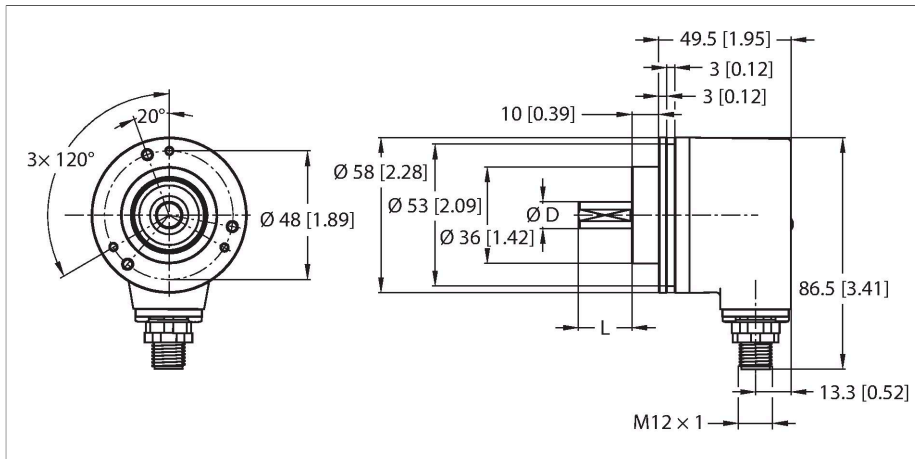

Technical data

Type	REM-103S6C-3C13S12M-H1181
ID	100011375
Measuring principle	Optical
General data	
Max. Rotational Speed	8000 rpm
Moment of inertia of the rotor	$3 \times 10^{-6} \text{ kgm}^2$
Starting torque	< 0.05 Nm
Absolute accuracy	$\pm 0.015^\circ$ At 25 °C
Output type	Absolute multiturn
Resolution singleturn	13 Bit
Resolution multiturn	12 Bit
Electrical data	
Operating voltage	10...30 VDC
No-load current	30 mA
Short-circuit protection	yes
Wire breakage/Reverse polarity protection	yes
Communication protocol	SSi
Output function	Gray coded
Mechanical data	
Design	Solid shaft
Flange type	Clamping flange
Flange diameter	Ø 58 mm
Shaft Type	Solid shaft
Shaft diameter D [mm]	6
Shaft Length L [mm]	10

Features

- Clamping flange, Ø 58 mm
- Solid shaft, Ø 6 mm × 10 mm
- Optical measuring principle
- Shaft material: stainless steel
- Protection class IP67 on housing and shaft side
- -40...+85 °C
- Max. 8000 rpm (continuous operation 5000 rpm)
- 10...30 VDC
- SSI, gray
- M12 × 1 male, 8-pin
- Singleturn, 13-bit resolution
- Multiturn, 12-bit resolution

Wiring diagram

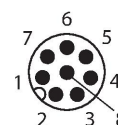
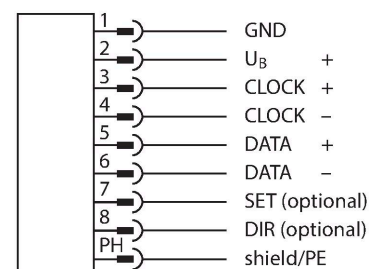

Technical data

Shaft material	Stainless steel
Housing material	Die-cast zinc
Electrical connection	Connector, M12 × 1
	8-polig
Axial shaft load	40 N
Radial shaft load	80 N
Environmental conditions	
Ambient temperature	-40...+85 °C
Vibration resistance (EN 60068-2-6)	100 m/s ² , 10...2000 Hz
Shock resistance (EN 60068-2-27)	2500 m/s ² , 6 ms
Protection class	IP67
Protection class shaft	IP67

Accessories

RCS-19-10-06 1545358

Bellows coupling, outer diameter:
19 mm, bore diameter: 10 mm/6 mm

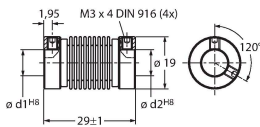

RCS-15-08-06 1545361

Bellows coupling, outer diameter:
15 mm, bore diameter: 8 mm/6 mm

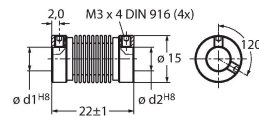

RCS-15-06-06 1545362

Bellows coupling, outer diameter:
15 mm, bore diameter: 6 mm/6 mm

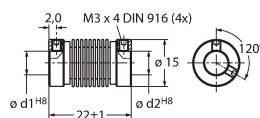

RCS-19-06-06 1545360

Bellows coupling, outer diameter:
19 mm, bore diameter: 6 mm/6 mm

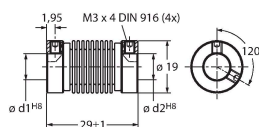

Accessories

Dimension drawing	Type	ID	
-------------------	------	----	--

E-RKC 8T-264-2

U-04781

Connection cable, female M12, straight, 8-pin (twisted pairs), shielded, cable length: 2 m, sheath material: PVC, black; cULus approval; other cable lengths and qualities available, see www.turck.com

