

WKC4.4T-P7X3.1-2-RSC4.4T/TXO3701

Welding Spark Resistant Actuator and Sensor Cable – Extension Cable

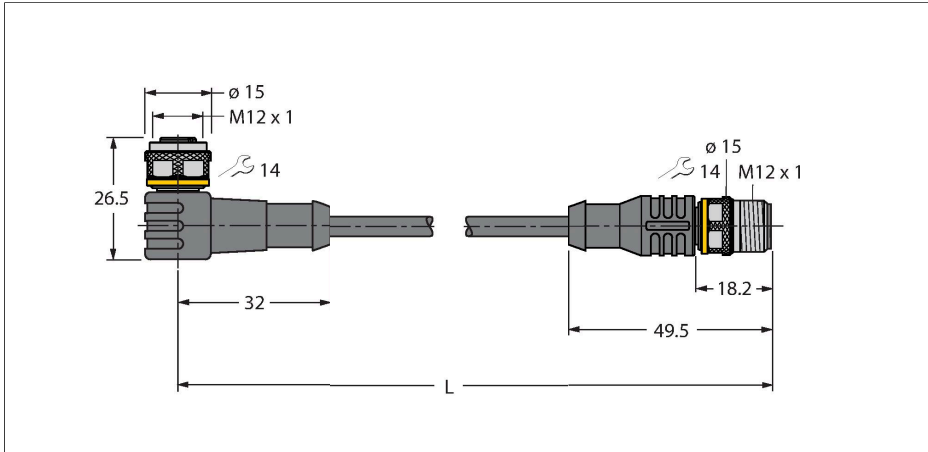

Features



- Female M12, angled, 4-pin
- With 3-color LED (PNP, red, yellow, green)
- Male M12, straight, 4-pin
- Jacket material: PUR
- Jacket color: orange
- Resistant to welding sparks
- Suitable for drag chain use
- Resistant to chemicals, UV radiation and oils
- Flame retardant (FT2 acc. to UL/CSA; IEC 60332-1-2; IEC 60332-2-2)
- Halogen free (acc. to EN 50267-2-1)
- Free from silicone, PVC and LABS (acc. to PV3.10.7)
- Particularly resistant to abrasion
- Protection class: IP67, IP69K
- Cable length: 2.0 m

Contact assignment



Circuit Diagram

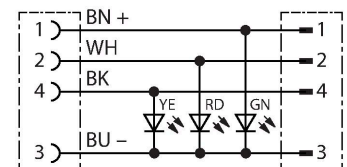

Technical data

Type	WKC4.4T-P7X3.1-2-RSC4.4T/TXO3701
ID	6635652
Remark to product	Specification according to VASS requirements (version: February 2021)
Connector A	Female, M12 × 1, Angled, A-coded
Number of Pins	4
Contacts	Brass, CuZn, Gold-plated
Contact carriers	Plastic, TPU, Black
Connector body	Plastic, TPU, Translucent
Coupling nut/screw	Brass, CuZn, Nickel-plated
Seal	Plastic, FPM/FKM
LED display	triple LED
Display operating voltage	LED, Green
Display switch state	LED, Yellow/red
Mechanical lifespan	> 100 Mating cycles
Pollution degree	3
Protection class	IP67, IP69K, Only in screwed condition
Connector B	Male, M12 × 1, Straight, A-coded
Number of pins	4
Contacts	Brass, CuZn, Gold-plated
Contact carriers	Plastic, TPU, Black
Connector body	Plastic, TPU, Black
Coupling nut/retaining screw	Brass, CuZn, Nickel-plated
Mechanical life	> 100 Mating cycles
Pollution degree	3
Protection class	IP67, IP69K, Only when screwed together

Technical data

Cable	
Cable diameter	Ø 5.6 mm ±0.20
Cable length	2 m
Cable jacket	PUR, Orange
Core insulation	PP
Core cross-section	4 x 0.34 mm ²
Core colors	BN, WH, BU, BK
Electrical properties at +20 °C	
Rated voltage	30 V _{DC}
Test voltage	2000 V
Current	4 A
forward resistance	max. 60 Ω/km
Mechanical and chemical properties	
Bending radius (stationary installation)	≥ 5 x Ø
Bending radius (flexible use)	≥ 10 x Ø
Bending cycles	≥ 5 million
Admissible acceleration	max. 10 m/s ²
Admissible travel path, horizontal	10 m (at 10 m/s ²)
Admissible travel path, vertical	10 m (at 10 m/s ²)
Admissible traversing speed	3.3 m/s
Torsional stress	± 180 °/m
Ambient temperature range (stationary)	-40...+80 °C
Ambient temperature range (In motion)	-25...+80 °C
Ambient temperature during drag chain operation	-25...+60 °C
Approvals	cULus

Accessories

TORQUE-WRENCH-SET-AS	6936170
Torque wrench set; handles with adjustable torque 0.4-1.0 Nm, torque wrench for M8 (SW9), fork wrench for M12 (SW 14)	

Accessories

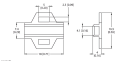
Dimension drawing	Type	ID	
	LABEL-HOLDER-FLEX-PVC	100048170	PVC label holder for identification of extension cables (TEL/TXL product series); for cable diameters: min. 5 mm; dimensions 4 x 18 mm; delivery unit: 50 pcs. per package