

S30SN6R W/30

Photoelectric Sensor – Opposed Mode Sensor (Receiver)

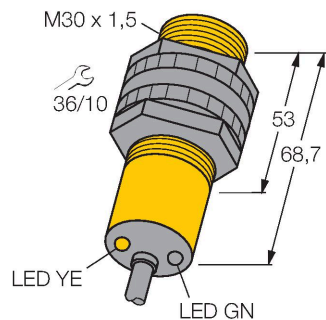

Features

- Cable, 2 m
- Protection class IP67
- Ambient temperature: -40...+70 °C
- Selectable light/dark operation or light operation with alarm function
- Operating voltage: 10...30 VDC
- NPN switching output, changeover

Wiring diagram

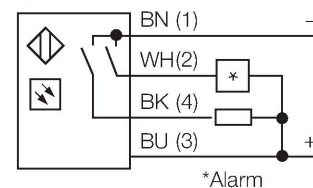
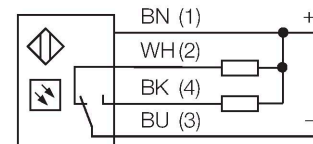

Functional principle

Opposed mode sensors consist of an emitter and receiver. They are installed opposite each other so that the light from the emitter is aimed directly at the receiver. When an object interrupts or weakens the light beam, the sensor switches. Opposed mode sensors are the most reliable photoelectric sensors for detection of opaque targets. An excellent contrast between light and dark conditions and an extremely high excess gain are typical of this sensing mode, thus allowing operation over larger distances and under difficult conditions. Excess gain curve
Excess gain in relation to the distance

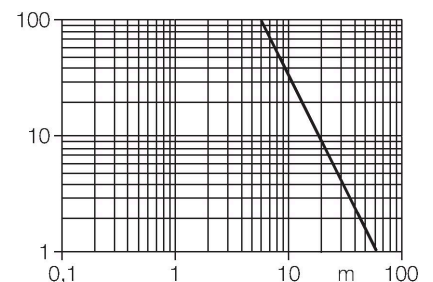

Technical data

Type	S30SN6R W/30
ID no.	3033893
Optical data	
Function	Opposed mode sensor
Operating mode	Receiver
Range	0...60000 mm
Electrical data	
Operating voltage	10...30 VDC
No-load current	≤ 25 mA
Short-circuit protection	yes / Cyclic
Reverse polarity protection	yes
Output function	Connection programmable, NPN
Switching frequency	≤ 160 Hz
Readiness delay	≤ 100 ms
Response time typical	< 3 ms
Overcurrent release	> 220 mA
Mechanical data	
Design	Threaded barrel, S30
Dimensions	Ø 30 x 68.7 mm
Housing material	Plastic, Thermoplastic material
Lens	plastic, Acrylic
Electrical connection	Cable, 9 m, PVC
Number of cores	4
Core cross-section	0.5 mm ²
Ambient temperature	-40...+70 °C
Protection class	IP67
Special features	Encapsulated

Technical data

Power-on indication	LED, Green
Switching state	LED, Yellow
Error indication	LED, green, Flashing
Excess gain indication	LED
Alarm display	LED yellow Flashing
Tests/approvals	
Approvals	CE, UL, CSA

Accessories

SMB30A 3032723

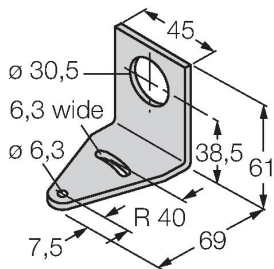

Mounting bracket, rectangular, stainless steel, for sensors with 30mm thread

SMB30FAM10 3011185

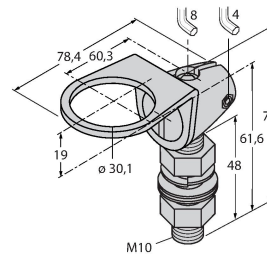

Mounting bracket, stainless steel, for M10 x 1.5 thread, thread length 30 mm

SMB30SC 3052521

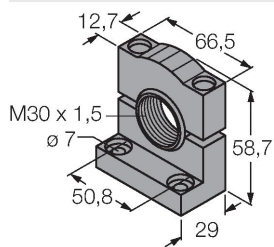

Mounting bracket, PBT black, for sensors with 30 mm thread, rotatable

SMBAMS30P 3073135

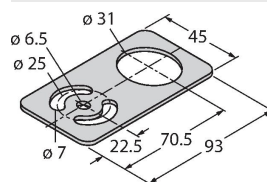

Mounting bracket, stainless steel, for sensors with 30 mm thread