

Set for Simple I/O Communication via Ethernet Modbus/TCP/ EtherNet/IP/ Profinet in IP20

TI-BL20-E-EN-S-2

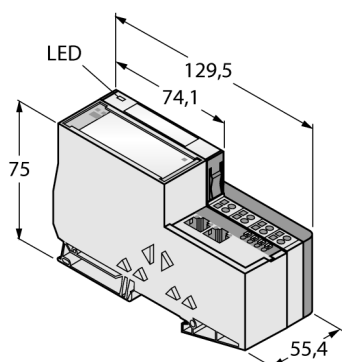

- A special software (function module) for integration in PLC systems is not required.
- Cable length between interface and read/write head: up to 50 m
- Connection of up to 2 read/write heads via BLident ® M12 extension cables
- Mixed operation of HF and UHF read/write heads

Functional principle

BL ident can be integrated into your plant structure in many different ways.

Various fieldbus standards, such as PROFIBUS-DP, EtherNet/IP, Ethernet Modbus TCP, EtherCAT, DeviceNet, CANopen and PROFINET IO allow flexible integration.

BL ident simple electronic modules (BL20-2RFID-S, BL67-2RFID-S) can be integrated into existing control or host systems without function block, since standard input/output process data is used for communication.

Programmable gateways with peripheral pre-processing function relieve the control system and fieldbus level.

Preassembled sets (2, 4, 6 or 8-port), easily mounted, available for all fieldbus networks.

Type designation	TI-BL20-E-EN-S-2
Ident no.	7030630
Number of channels	2
Dimensions (W x L x H)	55.4 x 129.5 x 74.4 mm
Rated voltage from the supply terminal	24 VDC
Supply voltage	24 VDC
System power supply	24 VDC / 5 VDC
Field supply	24 VDC
Admissible range	18...30 VDC
Max. field supply current	8
Max. system supply current	0.4
Service interface	Ethernet
Voltage supply connection	Push-in terminals
Transmission rate	115.2 kbps
Electrical isolation	Electronics and field level isolated via opto-couplers
Output connectivity	Screw, tension spring
Sensor supply	0.25 A per channel, short-circuit proof
Number of diagnostics bytes	4
Number of parameter bytes	8
Number of input bytes	24
Number of output bytes	24
Relative humidity	15...95 %, no condensation allowed
Vibration test	Acc. to EN 61131
Shock test	Acc. to IEC 60068-2-27
Drop and topple	acc. to IEC 68-2-31 and free fall to IEC 68-2-32
Electromagnetic compatibility	Acc. to EN 50082-2
Protection class	IP20
Included in delivery	2 x end brackets BL20-WEW-35/2-SW, 1 x end plate BL20-ABPL

Set for Simple I/O Communication via Ethernet Modbus/TCP/ EtherNet/IP/ Profinet in IP20

TI-BL20-E-EN-S-2

Anschlussübersicht

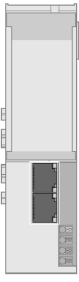
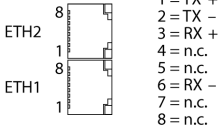
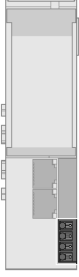
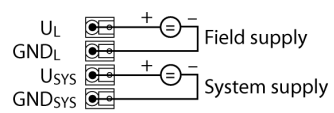
	<p>Ethernet Fieldbus cable (example): RJ45S-RJ45S-441-2M (ident no. 6932517) or RJ45-FKSDD-441-0,5M/S2174 (ident no. 6914221)</p>	<p>Pin Assignment</p> 
	<p>Power Supply The U_{SYS} system supply feeds power to the gateway and the I/O modules. The U_{L} field supply feeds power to the sensors and actuators.</p>	<p>Pin Assignment</p> 

**Set for Simple I/O Communication via Ethernet Modbus/TCP/ EtherNet/IP/
Profinet in IP20
TI-BL20-E-EN-S-2**

Compatible base modules

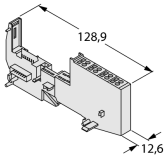
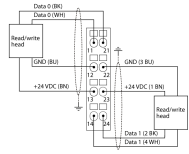
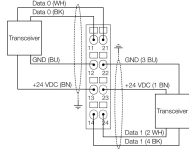
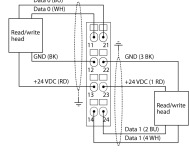
Dimension drawing	Type	Pin configuration
	<p>BL20-S4T-SBBS 6827046 Tension spring connection</p> <p>BL20-S4S-SBBS 6827047 Screw connection</p>	<p>Pin configuration</p> <p>.../S2500 Connectors</p>  <p>.../S2501 Connectors</p>  <p>Connectors .../S2503</p> 

Set for Simple I/O Communication via Ethernet Modbus/TCP/ EtherNet/IP/ Profinet in IP20

TI-BL20-E-EN-S-2

LED display

LED	Color	Status	Meaning
D		OFF	Error report or diagnostics active.
	RED	ON	Failure of MODBUS communication Check if more than 2 adjacent electronic modules are pulled. Relevant modules are located between gateway and this module.
	RED	FLASHING (0.5 Hz)	Upcoming module diagnostics
RW0/RW1		OFF	No tag, no active diagnostics
	GREEN	ON	Tag available
	GREEN	FLASHING (2 Hz)	Data exchange with tag enabled
	RED	ON	Read/write head error
	RED	FLASHING (2 Hz)	Short-circuit in the supply line of read/write head

Set for Simple I/O Communication via Ethernet Modbus/TCP/ EtherNet/IP/ Profinet in IP20



TI-BL20-E-EN-S-2

I/O Data Mapping

INPUT	BYTE	Bit 7	Bit 6	Bit 5	Bit 4	Bit 3	Bit 2	Bit 1	Bit 0	
Channel 0	0	DONE	BUSY	ERROR	XCVR CON	XCVR ON	TP	TFR	Reserved	
	1	Error Code								
	2	Error Code 1								
	3	Reserved								
	4	READ DATA (8 Byte)								
	5									
	...									
	10									
	11									
	Channel 1	12	DONE	BUSY	ERROR	XCVR CON	XCVR ON	TP	TFR	Reserved
		13	Error Code							
14		Error Code 1								
15		Reserved								
16		READ DATA (8 Byte)								
17										
...										
22										
23										
OUTPUT		BYTE	Bit 7	Bit 6	Bit 5	Bit 4	Bit 3	Bit 2	Bit 1	Bit 0
Channel 0	0	XCVR	NEXT	TAG ID	READ	WRITE	TAG INFO	XCVR INFO	RESET	
	1	Reserved					Byte Count 2	Byte Count 1	Byte Count 0	
	2	Address high byte								
	3	Address low byte								
	4	WRITE DATA (8 Byte)								
	5									
	...									
	10									
	11									
	Channel 1	12	XCVR	NEXT	TAG ID	READ	WRITE	TAG INFO	XCVR INFO	RESET
		13	Reserved					Byte Count 2	Byte Count 1	Byte Count 0
14		Address high byte								
15		Address low byte								
16		WRITE DATA (8 Byte)								
17										
...										
22										
23										

**Set for Simple I/O Communication via Ethernet Modbus/TCP/ EtherNet/IP/
Profinet in IP20
TI-BL20-E-EN-S-2**

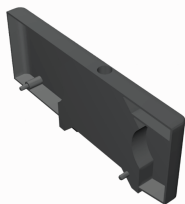
Accessories

Type code	Ident no.		Dimension drawing
BL20-ABPL (2 PCS.)	6827123	End plate for a BL20 station after the last I/O module (2 pieces)	
BL20-WEW-35/2-SW (10 PCS.)	6827124	End bracket for fixation of a BL20 station (10 pieces)	
ZBW5-2BETÄTIGUNGSWERKZEUG	6827125	Tension spring tool	