

Q20PFF100Q

Photoelectric Sensor – Diffuse Mode Sensor with Fixed-Field Background Suppression

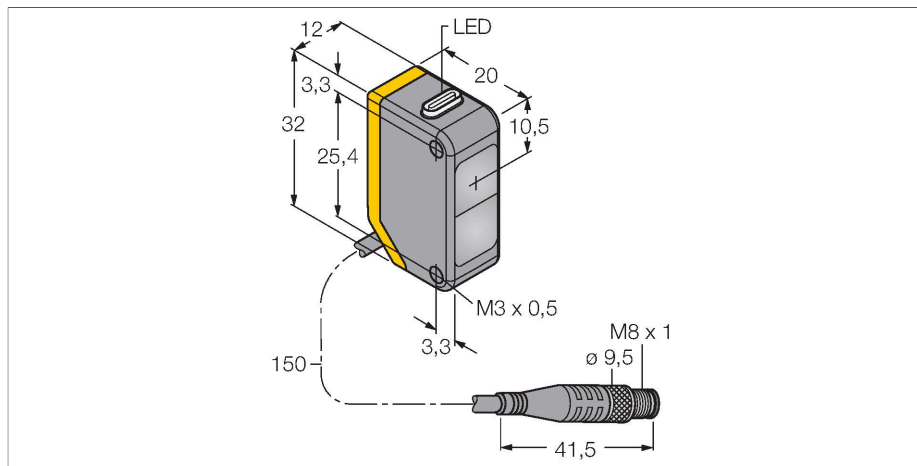

Technical data

Type	Q20PFF100Q
ID no.	3078219
Optical data	
Function	Proximity switch
Operating mode	Background suppression, non-adjustable
Light type	Red
Wavelength	655 nm
Range	0...100 mm
Electrical data	
Operating voltage	10...30 VDC
Residual ripple	< 10 % U _{ss}
DC rated operational current	≤ 100 mA
No-load current	≤ 18 mA
Reverse polarity protection	yes
Output function	Complementary contact, PNP
Switching frequency	≤ 600 Hz
Readiness delay	≤ 100 ms
Response time typical	< 0.8 ms
Mechanical data	
Design	Rectangular, Q20
Dimensions	20 x 12 x 32 mm
Housing material	Plastic, Thermoplastic material
Lens	plastic, Acrylic
Electrical connection	Cable with connector, M8 × 1, 0.15 m, PVC
Number of cores	4

Features

- Cable with male end, PVC, M8 × 1, 4-pin, 150 mm
- Protection class IP67
- LED all-round visible
- Operating voltage: 10...30 VDC
- PNP switching output, changeover

Wiring diagram

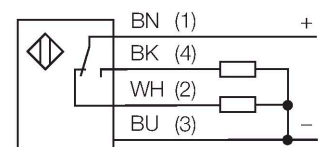

Functional principle

Diffuse mode sensors with background suppression operate with a single emitter and several receiver elements. The target position and the photoelectric structure of the sensor determine which receiver element gets the most light. The sensor electronics determine whether the reflecting object is within or outside the measuring range. These sensors come with a fixed cut-off point.

Excess gain curve
Excess gain in relation to the distance

Technical data

Ambient temperature	-20...+60 °C
Protection class	IP67
Power-on indication	LED, Green
Switching state	LED, Yellow
Error indication	LED, green, Flashing
Excess gain indication	LED, yellow, flashing
Tests/approvals	
Approvals	CE

Excess Gain Curve

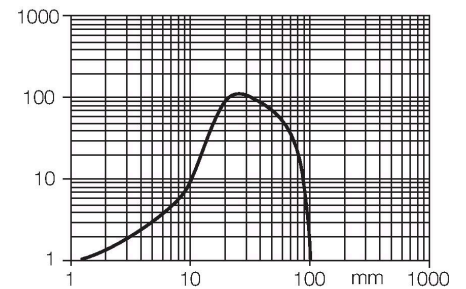

Accessories

SMBQ20H 3079041

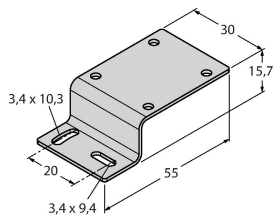

Mounting bracket, stainless steel, horizontally mounted, for Q20

SMBQ20L 3079040

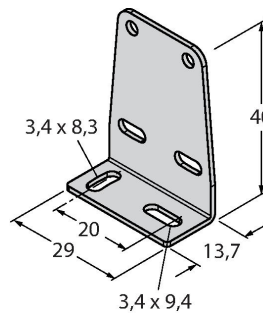

Mounting bracket, stainless steel, rectangular, for Q20

SMBQ20LV 3079042

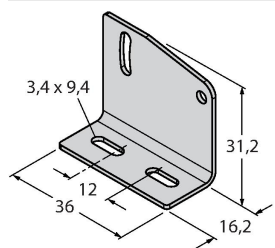

Mounting bracket, stainless steel, rectangular, for Q20

SMBQ20U 3079043

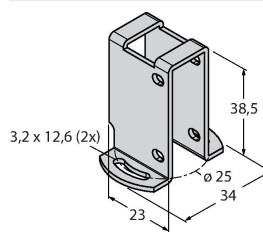

Protective housing, stainless steel, for Q20

Accessories

Dimension drawing	Type	ID no.	
-------------------	------	--------	--



PKW4M-2/TEL

6625067

Connection cable, female M8, angled, 4-pin, cable length: 2 m, sheath material: PVC, black; cULus approval; other cable lengths and qualities available, see www.turck.com



PKG4M-2/TEL

6625061

Connection cable, female M8, straight, 4-pin, cable length: 2 m, sheath material: PVC, black; cULus approval; other cable lengths and qualities available, see www.turck.com