

BIM-UNT-AY1X-0.3-RS4.21/S1139

Magnetic Field Sensor – For Pneumatic Cylinders

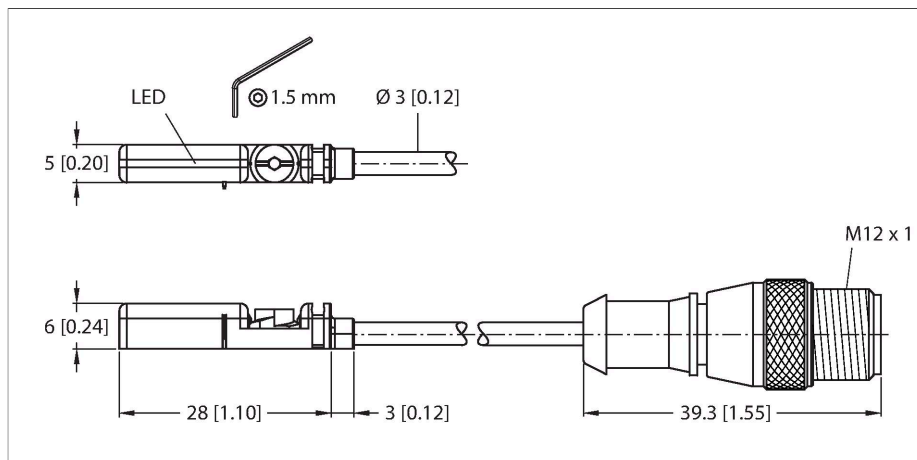

Features

- For T-groove cylinders without mounting accessories
- Optional accessories for mounting on other cylinder designs
- One-hand mounting possible
- Stable mounting
- Magneto-resistive sensor
- Long overtravel
- For large cylinders
- DC 2-wire, nom. 8.2 VDC
- Output acc. to DIN EN 60947-5-6 (NAMUR)
- Output with binary signal
- NO contact
- Pigtail with M12 × 1 connector
- ATEX category II 1 G, Ex Zone 0
- ATEX category II 1 D, Ex Zone 20

Technical data

Type	BIM-UNT-AY1X-0.3-RS4.21/S1139
ID	4685765
Special version	S1139 corresponds to: Long overtravel
General data	
Pass speed	≤ 10 m/s
Repeatability	≤ ± 0.1 mm
Temperature drift	≤ 0.1 mm
Hysteresis	≤ 1 mm
Electrical data	
Output function	2-wire, NAMUR
Switching frequency	1 kHz
Voltage	Nom. 8.2 VDC
Current consumption non-actuated	≤ 1.2 mA
Actuated current consumption	≥ 2.1 mA
Approval acc. to	KIWA 16 ATEX 0051 X
Internal capacitance (C _i)/inductance (L _i)	180 nF/350 µH
Device marking	Ex II 1 G Ex ia IIC T6 Ga/II 1 D Ex ia IIIC T95 °C Da (max. U _i = 20 V, I _i = 60 mA, P _i = 80 mW)
Mechanical data	
Design	Rectangular, UNT
Dimensions	28 x 5 x 6 mm
Housing material	Plastic, PP
Active area material	Plastic, PP
Tightening torque fixing screw	0.4 Nm
Electrical connection	Cable with connector, M12 × 1
Cable quality	Ø 3 mm, Blue, Lif9YYW, PVC, 0.3 m

Wiring diagram

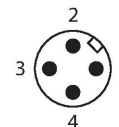
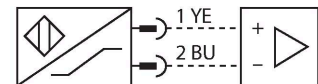

Functional principle

Magnetic field sensors are activated by magnetic fields and are especially suited for piston position detection in pneumatic cylinders. Based on the fact that magnetic fields can permeate non-magnetizable metals, it is possible to detect a permanent magnet attached to the piston through the aluminium wall of the cylinder.

Technical data

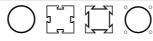
Core cross-section	2 x 0.14 mm ²
Environmental conditions	
Ambient temperature	-25...+70 °C
Vibration resistance	55 Hz (1 mm)
Shock resistance	30 g (11 ms)
Protection class	IP68
MTTF	2283 years acc. to SN 29500 (Ed. 99) 40 °C
Mounting on the following profiles	
Cylindrical design	
Switching state	LED, Yellow
Included in delivery	cable clip

Mounting instructions

Mounting instructions/Description

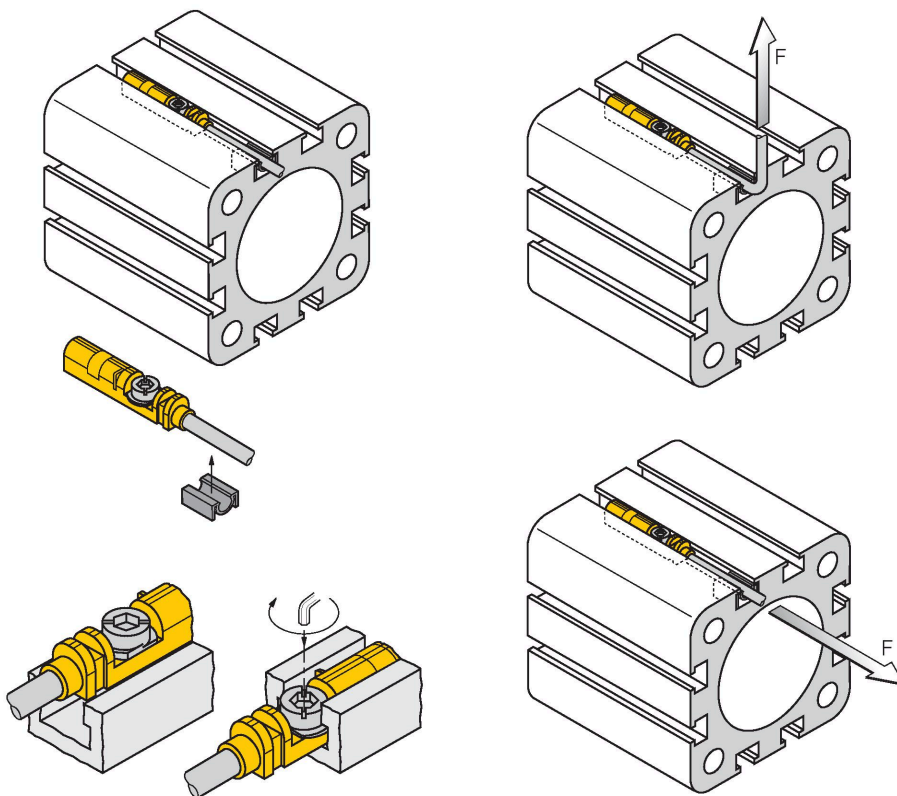

Thanks to the mounting lip, the sensor can be inserted into the groove from above with one hand. Mount the sensors as follows using the patented wing screw: The wing screw and the female thread feature a left-hand thread. Two small plastic lips keep the screw in position, ready-to-install. Turn the screw clockwise. The screw moves out of the thread and hits the upper grooves with the wings. The sensor is thus pressed down and locked in position. A few degrees up to approximately 1.5 turns of the screw with a slotted screwdriver (blade width 0.5 mm) or a 1.5 mm Allen key are sufficient to ensure vibration-proof fastening, depending on the shape of the slot. A tightening torque of 0.4 Nm is sufficient for safe mounting without damaging the cylinder. The sensor can now withstand an axial and radial tensile load of $F=100\text{N}$ applied on the cable. A cable clip is included in the scope of delivery. It enables smooth cable routing in the groove and ensures that the cable is fastened as securely as possible. The corresponding accessories for mounting on other cylindrical housings must be ordered separately.

Accessories

KLZCD2-UNT

6970418

Mounting bracket for mounting magnetic field sensors for T-grooves on a CleanDesign cylinder with mounting rail

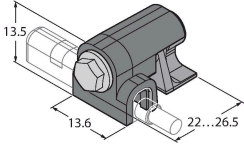

KLZ1-INT

6970410

Accessories for mounting the sensors BIM-INT and BIM-UNT on tie-rod cylinders; cylinder diameter: 32... 40 mm; material: Aluminum; further mounting accessories for other cylinder diameters on request

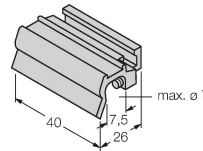

KLZ2-INT

6970411

Accessories for mounting the sensors BIM-INT and BIM-UNT on tie-rod cylinders; Cylinder diameter: 50... 63 mm; material: Aluminium; Further mounting accessories for other cylinder diameters on request

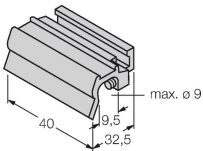

UNT-STOPPER

4685751

Accessories for finetuning the switchpoint on T-groove cylinders; snap-locked in the BIM-UNT fixture; suited for multiple use; material: plastic

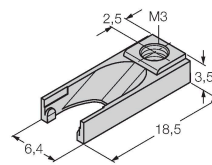

KLRC-UNT1

6970626

Mounting bracket for mounting magnetic field sensors on round cylinders; cylinder diameter: 8...25 mm; material: PA 6I/6T / nickel silver; fire-hazard classification acc. to UL94 - V2

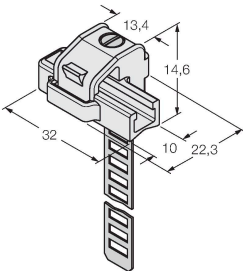

KLRC-UNT2

6970627

Mounting bracket for mounting magnetic field sensors on round cylinders; cylinder diameter: 25...63 mm; material: PA 6I/6T / nickel silver; fire-hazard classification acc. to UL94 - V2

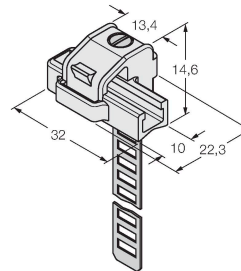

KLRC-UNT3

6970628

Mounting bracket for mounting magnetic field sensors on round cylinders; cylinder diameter: 63...130 mm; material: PA 6I/6T / nickel silver; fire-hazard classification acc. to UL94 - V2

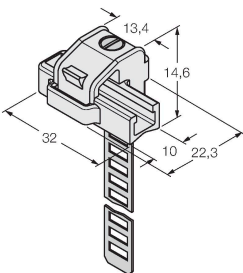

KLRC-UNT4

6970629

Mounting bracket for mounting magnetic field sensors on round cylinders; cylinder diameter: 130... 250 mm; material: PA 6I/6T / nickel silver; fire-hazard classification acc. to UL94 - V2

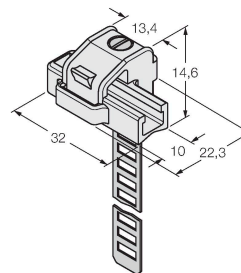

KLDT-UNT2

6913351

Mounting bracket for mounting magnetic field sensors on dovetail groove cylinders; groove width: 7 mm; material: PPS

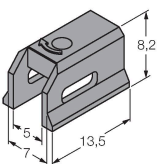

KLDT-UNT3

6913352

Mounting bracket for mounting magnetic field sensors on dovetail groove cylinders; groove width: 9.4 mm; material: PPS

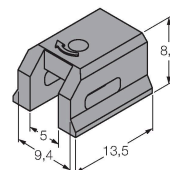

KLDT-UNT6

6913355

Mounting bracket for mounting magnetic field sensors on dovetail groove cylinders; groove width: 7.35 mm; material: PPS

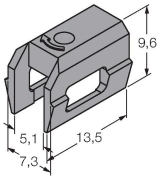

Accessories

Dimension drawing	Type	ID	
	IMX12-DI01-2S-2T-0/24VDC	7580020	Isolating switching amplifier, 2-channel; SIL2 acc. to IEC 61508; Ex-proof version; 2 transistor outputs; input Namur signal; ON/OFF switchable monitoring of wire-break and short-circuit; toggle between NO/NC mode; signal doubling; removable screw terminals; 12.5 mm wide; 24 VDC power supply

Instructions for use

Intended use	This device fulfills the directive 2014/34/EC and is suited for use in potentially explosive areas according to EN60079-0:2012, +A11:2013, -11:2012. In order to ensure that the device is operated as intended, the national regulations and directives must be observed.
For use in explosion hazardous areas conform to classification	II 1 G and II 1 D (Group II, Category 1 G, electrical equipment for gaseous atmospheres and category 1 D, electrical equipment for dust atmospheres).
Marking (see device or technical data sheet)	Ex II 1 G and Ex ia IIC T6 Ga and Ex II 1 D Ex ia IIIC T95 °C Da acc. to EN60079-0, +A11 and -11
Local admissible ambient temperature	-25...+70 °C
Installation/Commissioning	<p>These devices may only be installed, connected and operated by trained and qualified staff. Qualified staff must have knowledge of protection classes, directives and regulations concerning electrical equipment designed for use in explosion hazardous areas. Please verify that the classification and the marking on the device comply with the actual application conditions.</p> <p>This device is only suited for connection to approved Exi circuits according to EN 60079-0 and EN 60079-11. Please observe the maximum admissible electrical values. After connection to other circuits the sensor may no longer be used in Exi installations. When interconnected to (associated) electrical equipment, it is required to perform the "Proof of intrinsic safety" (EN60079-14).</p>
Installation and mounting instructions	Avoid static charging of cables and plastic devices. Please only clean the device with a damp cloth. Do not install the device in a dust flow and avoid build-up of dust deposits on the device. If the devices and the cable could be subject to mechanical damage, they must be protected accordingly. They must also be shielded against strong electro-magnetic fields. The pin configuration and the electrical specifications can be taken from the device marking or the technical data sheet. In order to avoid contamination of the device, please remove possible blanking plugs of the cable glands or connectors only shortly before inserting the cable or opening the cable socket.
Service/Maintenance	Repairs are not possible. The approval expires if the device is repaired or modified by a person other than the manufacturer. The most important data from the approval are listed.