

LT3PULV

Photoelectric Sensor – Retroreflective Sensor

Laser Running Time Meter



Technical data

Type	LT3PULV
ID no.	3067273
Optical data	
Function	Retroreflective Sensor
Operating mode	Runtime
Reflector included in delivery	yes
Light type	Red
Wavelength	658 nm
Laser class	▲ 1
Repeatability	4.5 mm
Range	500...50000 mm
Ambient light immunity	5000 lux
Electrical data	
Operating voltage	12...24 VDC
Residual ripple	< 10 % U _{ss}
DC rated operational current	≤ 100 mA
No-load current	≤ 108 mA
Short-circuit protection	yes
Reverse polarity protection	yes
Output function	NO contact, PNP/Analog output
Type of analog output	0...10 V
Voltage output	0...10 V
Load resistance	≥ 2500 Ω
Switching frequency	≤ 1000 Hz
Readiness delay	≤ 1 s
Readiness delay	≤ 1000 ms

Features

- Cable, 2 m, 7-wire
- Indication of signal intensity
- Protection class IP67
- BRT-TVHG-8X10P highly reflective foil, incl. in delivery
- Measuring range with according reflector foil: 50 m
- 3 response times adjustable for switching output
- Operating voltage: 12...24 VDC
- Hysteresis and measuring range independently adjustable
- Edge of the analog output invertible

Wiring diagram

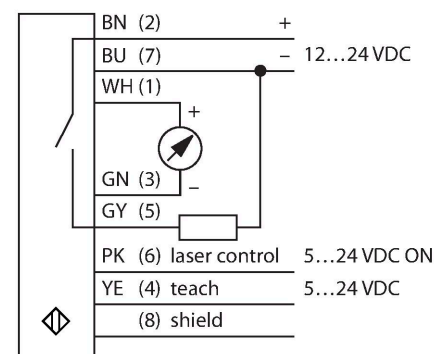

Functional principle

This distance sensor uses pulsed time-of-flight technology and is thus extremely powerful. The laser pulses one million times per second. The microprocessor records the time required for each pulse to travel to the object and back to the sensor. Every millisecond, one thousand pulse times are averaged and the

Technical data

Response time typical	< 1 ms
Mechanical data	
Design	Rectangular, LT3
Dimensions	87 x 35.3 x 68.5 mm
Housing material	Plastic, ABS, Black
Lens	plastic, Acrylic
Electrical connection	Cable, 2 m, PVC
Number of cores	8
Core cross-section	0.34 mm ²
Ambient temperature	0...+50 °C
Relative humidity	90 %
Protection class	IP67
Special features	Laser Teach input
Power-on indication	LED, Green
Switching state	LED, Yellow
Error indication	LED
Excess gain indication	LED, red
Tests/approvals	
MTTF	15 years acc. to SN 29500 (Ed. 99) 40 °C
Approvals	CE, cURus

corresponding value is transferred to the output.
The sensor achieves its highest accuracy after a 30-min. warm-up period.

Resolution in Dependence on Distance

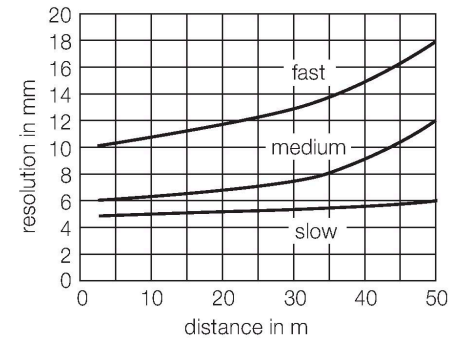

Accessories

SMBAMSLT3IP

3073442

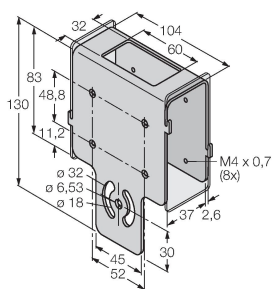

Protective housing with safety glass panel, for LT3 series

SMBAMSLT3P

3073132

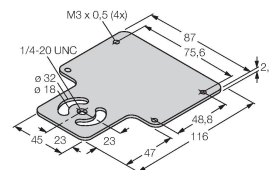

Backplane, stainless steel, for LT3 series

SMBLT31

3068505

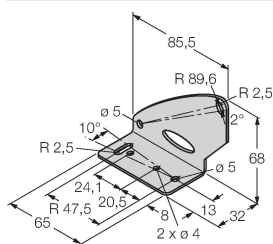

Mounting bracket, stainless steel, for LT3 series

SMBLT32

3069236

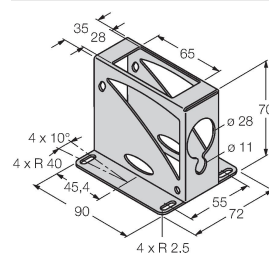

Protective housing, stainless steel, for LT3 series

SMBLT3IP

3070973

Protective housing, stainless steel, for LT3 series

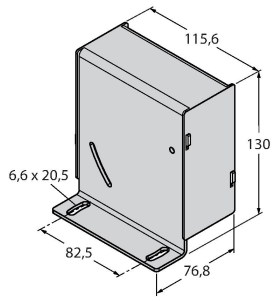

Accessories

Dimension drawing	Type	ID no.	
	BRT-TVHG-8X10P	3069119	Reflective foil, self-adhesive, cuttable, highly reflective, 203 x 254 mm