

SM312DVQD

Photoelectric Sensor – Diffuse Mode Sensor

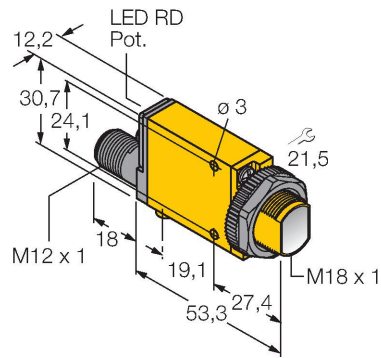

Features

- Male M12 × 1, 4-pin
- Protection class IP67
- Sensitivity adjustable via potentiometer
- Alignment indicator
- Operating voltage: 10...30 VDC
- Switching output, bipolar
- Light/dark operation

Wiring diagram

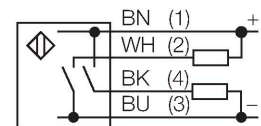

Technical data

Type	SM312DVQD
ID no.	3028918
Optical data	
Function	Proximity switch
Operating mode	Diffuse
Light type	IR
Wavelength	880 nm
Range	0...380 mm
Electrical data	
Operating voltage	10...30 VDC
Residual ripple	< 10 % U _{ss}
DC rated operational current	≤ 150 mA
No-load current	≤ 25 mA
Output function	NO contact, PNP/NPN
Switching frequency	≤ 500 Hz
Readiness delay	≤ 100 ms
Response time typical	< 1 ms
Overcurrent release	> 220 mA
Setting option	Potentiometer
Mechanical data	
Design	Rectangular with thread, Mini Beam
Dimensions	Ø 18 x 71.3 x 12.3 x 30.7 mm
Housing material	Plastic, Thermoplastic material, Yellow
Lens	plastic, Acrylic
Electrical connection	Connectors, M12 × 1, PVC
Number of cores	4
Ambient temperature	-20...+70 °C

Functional principle

Diffuse mode sensors incorporate the emitter and receiver in a single housing. However, diffuse mode sensors do not detect the interruption of the light beam like opposed mode sensors, but the reflection of the target. A target is detected if it reflects a sufficient amount of light back to the receiver. The switching distance of diffuse mode sensors thus largely depends on the reflectivity of the target.

Excess gain curve
Excess gain in relation to the distance

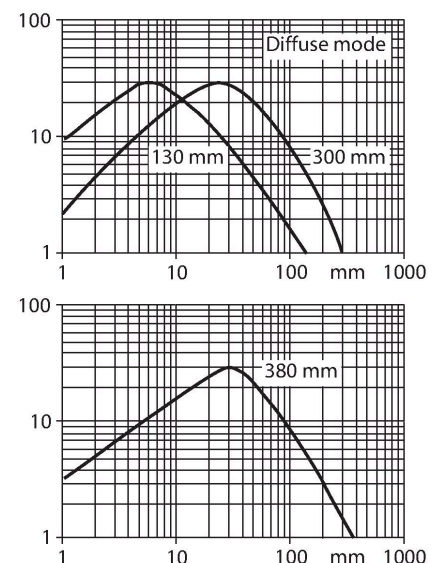

Technical data

Protection class	IP67
Switching state	LED, Red
Excess gain indication	LED, red, flashing
Tests/approvals	
Approvals	CE, cURus, CSA

Accessories

SMB18A 3033200

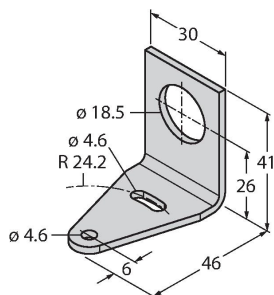

Mounting bracket, rectangular, stainless steel, for sensors with 18 mm thread

SMB18AFAM10 3012558

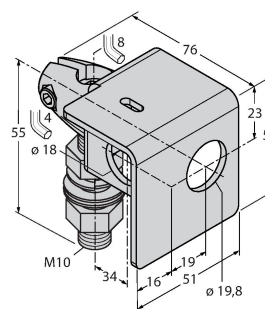

Mounting bracket, material VA 1.4401, for M10 x 1.5 thread, thread length 18 mm

SMB18SF 3052519

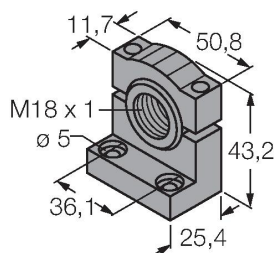

Mounting bracket, PBT black, for sensors with 18 mm thread, rotatable

SMB312B 3025519

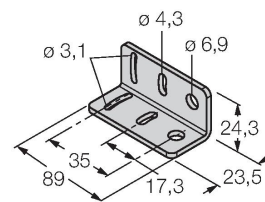

Mounting bracket, stainless steel, for MINI-BEAM NAMUR

SMB3018SC 3053952

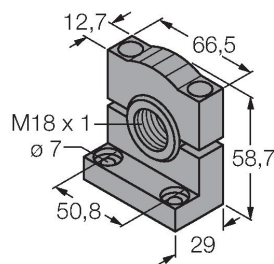

Mounting bracket, PTB black, for sensors with 18 mm thread