

# RKS56PLB-3-RSS56PLB/TXG

## Supply Cable — M12 Power – Extension Cable

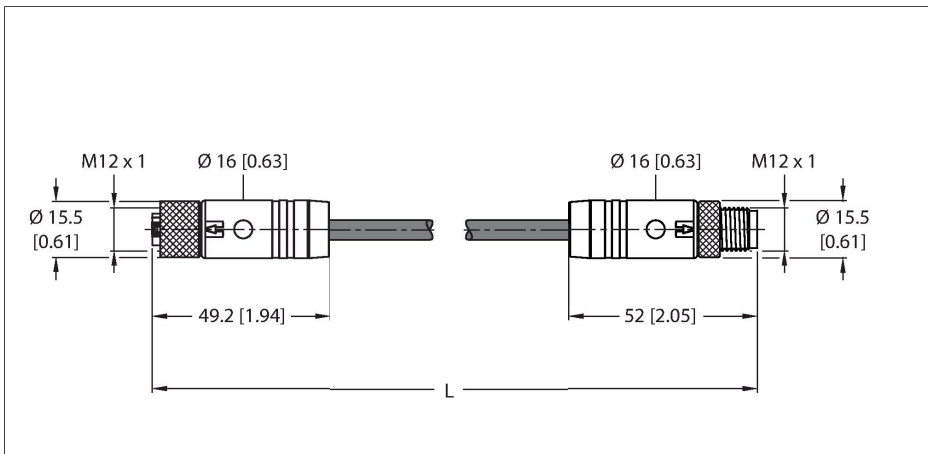

### Technical data

Type	RKS56PLB-3-RSS56PLB/TXG
ID	100023945
Connector A	Female, M12 × 1, Straight, L-coded
Number of Pins	4+FE
Contacts	Copper-nickel, CuNi, Gold-plated
Contact carriers	Plastic, PBT GF, Black
Connector body	Plastic, TPE, Black
Coupling nut/screw	Brass, CuZn, Nickel-plated
Seal	Plastic, FPM/FKM
Tightening torque (range)	0.5 ... 0.6 Nm (observe max. torque of mating connector!)
Mechanical lifespan	> 100 Mating cycles
Pollution degree	3
Protection class	IP65, IP67, IP69K, Only in screwed condition
Connector B	Male, M12 × 1, Straight, L-coded
Number of pins	4+FE
Contacts	Copper-nickel, CuNi, Gold-plated
Contact carriers	Plastic, PBT GF, Black
Connector body	Plastic, TPE, Black
Coupling nut/retaining screw	Brass, CuZn, Nickel-plated
Tightening torque	0.5 ... 0.6 Nm (observe max. torque of mating connector!)
Mechanical life	> 100 Mating cycles
Pollution degree	3
Protection class	IP65, IP67, IP69K, Only when screwed together

### Features



- M12 female connector, L-coded, straight, 5-pin (4+FE)
- Shield on coupling nut
- M12 male connector, L-coded, straight, 5-pin (4+FE)
- Jacket material: PUR
- Jacket color: gray
- Highly resistant to oils, coolants, lubricants and emulsions
- Suitable for use in drag chains
- Resistant to vibrations and shocks
- Flame retardant
- Halogen-free
- RoHS compliant
- UL approval
- Protection class: IP65, IP67, IP69K
- Cable length: 3 m

### Contact assignment



## Technical data

Cable	
Cable diameter	Ø 10.4 mm ±0.20
Cable length	3 m
Cable jacket	PUR, Gray
Core insulation	PP
Core cross-section	5 x 1.5 mm <sup>2</sup>
Core colors	BN, WH, BU, BK, PK
Electrical properties at +20 °C	
Rated voltage	50 V <sub>AC</sub> /60 V <sub>DC</sub>
Current	16 A
Mechanical and chemical properties	
Bending radius (stationary installation)	≥ 4 x Ø
Bending radius (flexible use)	≥ 7 x Ø
Bending cycles	≥ 10 million
Admissible acceleration	max. 5 m/s <sup>2</sup>
Admissible travel path, horizontal	5 m (at 5 m/s <sup>2</sup> )
Ambient temperature range (stationary)	-40...+80 °C
Ambient temperature range (In motion)	-30...+80 °C
Ambient temperature during drag chain operation	-20...+60 °C
Qualified for drag chain use	yes
Halogen-free	yes
Oil-resistant	yes
Flame-retardant	yes
Approvals	cULus

## Circuit Diagram

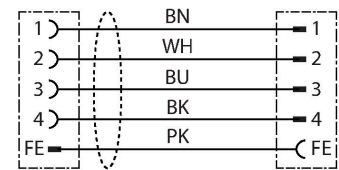

## Derating Curve

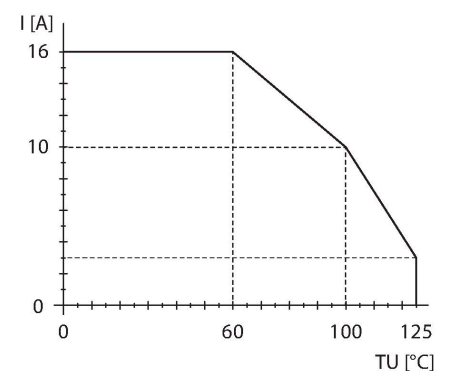

## Accessories

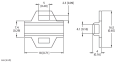
Dimension drawing	Type	ID	
	LABEL-HOLDER-FLEX-PVC	100048170	PVC label holder for identification of extension cables (TEL/TXL product series); for cable diameters: min. 5 mm; dimensions 4 x 18 mm; delivery unit: 50 pcs. per package