

QS30AFQ

Photoelectric Sensor – Diffuse Mode Sensor with Adjustable Background Suppression

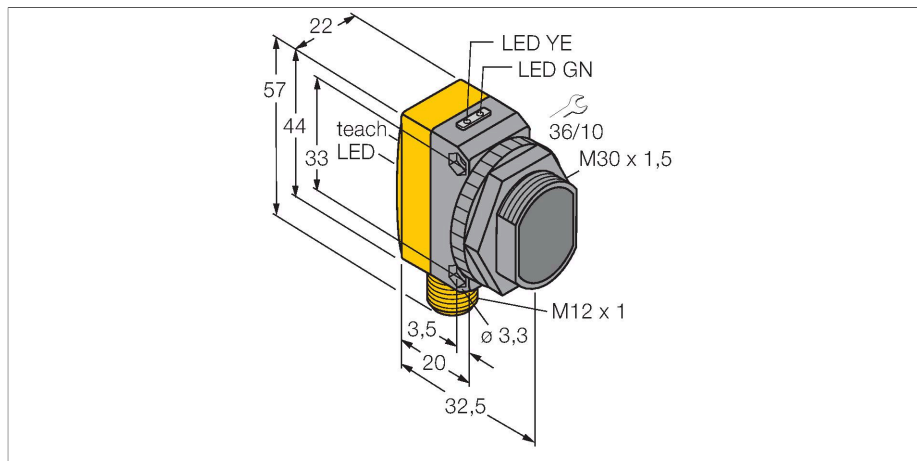

Technical data

Type	QS30AFQ
ID no.	3070381
Optical data	
Function	Proximity switch
Operating mode	Background suppression, adjustable
Light type	Red
Wavelength	660 nm
Range	50...300 mm
Electrical data	
Operating voltage	10...30 VDC
Residual ripple	< 10 % U _{ss}
DC rated operational current	≤ 150 mA
No-load current	≤ 45 mA
Short-circuit protection	yes
Reverse polarity protection	yes
Output function	NO contact, PNP/NPN
Switching frequency	≤ 500 Hz
Readiness delay	≤ 250 ms
Response time typical	< 1 ms
Setting option	Push Button Remote Teach
Mechanical data	
Design	Rectangular with thread, QS30
Dimensions	Ø 30 x 35 x 22 x 57 mm
Housing material	Plastic, Thermoplastic material, Yellow
Lens	plastic, Acrylic

Features

- Male M12 × 1, 5-pin
- Protection class IP67
- LED, all-round visible
- Cut-off point adjusted via teach button
- Operating voltage: 10...30 VDC
- Switching output, bipolar
- Light or dark operation

Wiring diagram

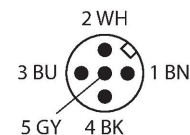
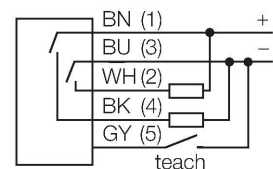

Functional principle

Diffuse mode sensors with background suppression operate with a single emitter and several receiver elements. The target's position and the optical structure of the sensor determine which receiver element gets the most light. The sensor electronics then determines whether the reflecting target is in or outside the measuring range. The sensors are available with adjustable or fixed cut-off point.

Excess gain curve
Excess gain in relation to distance

Technical data

Electrical connection	Connectors, M12 × 1, PVC
Number of cores	5
Ambient temperature	-10...+55 °C
Protection class	IP67
Special features	keep/defer
Power-on indication	LED, Green
Switching state	LED, Yellow
Error indication	LED, green, Flashing
Excess gain indication	Bargraph, red, flashing
Tests/approvals	
Approvals	CE

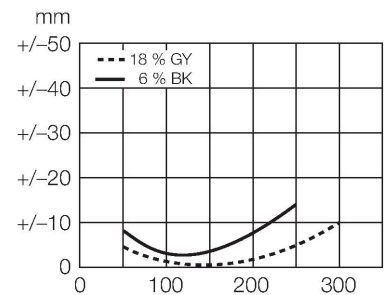
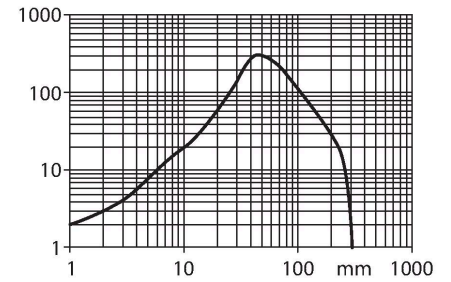

Accessories

SMB30A

3032723

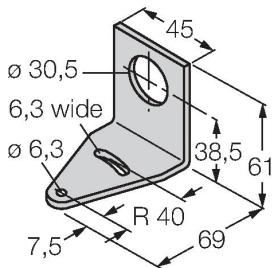

Mounting bracket, rectangular, stainless steel, for sensors with 30mm thread

SMBQS30L

3002809

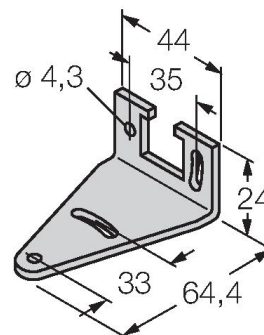

Mounting bracket, stainless steel, for QS30 series

SMB30MM

3027162

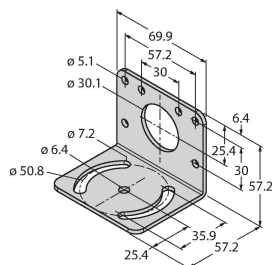

Mounting bracket, rectangular, stainless steel, for sensors with 30 mm thread, wide holes for accurate alignment

SMB30SC

3052521

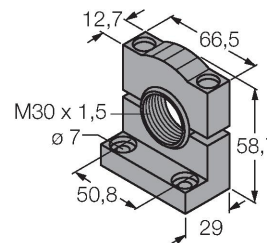

Mounting bracket, PBT black, for sensors with 30 mm thread, rotatable

Accessories

Dimension drawing	Type	ID no.	
	WKC4.5T-2/TEL	6625028	Connection cable, female M12, angled, 5-pin, cable length: 2 m, sheath material: PVC, black; cULus approval; other cable lengths and qualities available, see www.turck.com
	RKC4.5T-2/TEL	6625016	Connection cable, female M12, straight, 5-pin, cable length: 2 m, sheath material: PVC, black; cULus approval; other cable lengths and qualities available, see www.turck.com