

RI360P0-QR24M0-0600X2-H1181

Contactless Encoder – Incremental: 600 ppr

Premium Line

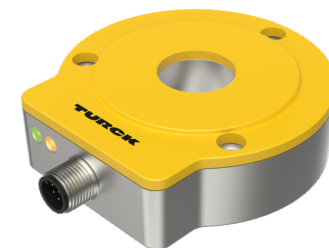
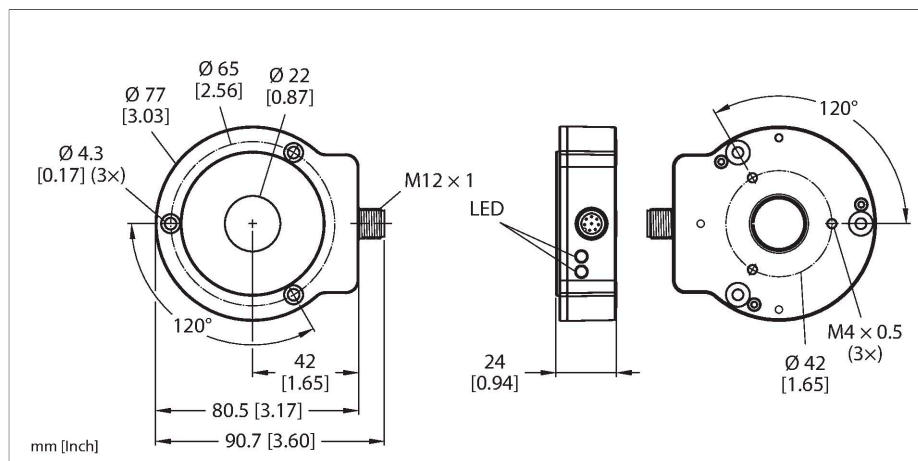

Technical data

Type	RI360P0-QR24M0-0600X2-H1181
ID	1593115
Measuring principle	Inductive
General data	
Max. Rotational Speed	10000 rpm
	Determined with standardized construction, with a steel shaft Ø 20 mm, L = 50 mm and reducer Ø 20 mm
Starting torque shaft load (radial / axial)	not applicable, because of contactless measuring principle
Nominal distance	1.5 mm
Repeat accuracy	≤ 0.01 % of full scale
Linearity deviation	≤ 0.05 % f.s.
Temperature drift	≤ ± 0.003 %/K
Output type	Incremental
Resolution, incremental	600 ppr
Electrical data	
Operating voltage	10...30 VDC
Residual ripple	≤ 10 % U _{ss}
Isolation test voltage	≤ 0.5 kV
Short-circuit protection	yes / Cyclic
Wire breakage/Reverse polarity protection	yes / yes (voltage supply)
Pulse frequency max.	200 kHz
Signal level high	min. U _B - 2 V
Signal level low	max. 2.0 V
Output function	8-pin, Push-Pull/HTL

Features

- Compact, rugged housing
- Many mounting possibilities
- Status displayed via LED
- Immune to electromagnetic interference
- Position of z-track can be set via Easy-Teach
- Burst function, absolute angular position output incrementally via Easy-Teach pulse
- 10...30 VDC
- Male M12 x 1, 8-pin
- Push-pull A, B, Z, A (inverse), B (inverse)

Wiring diagram

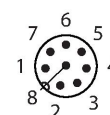
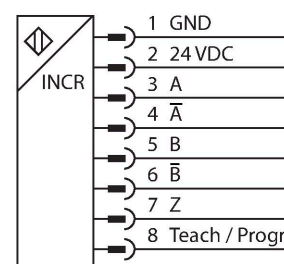

Functional principle

The measuring principle of inductive angle sensors is based on oscillation circuit coupling between the positioning element and the sensor, whereby an output signal is provided

Technical data

Sample rate	1000 Hz
Current consumption	< 100 mA
Mechanical data	
Design	QR24
Dimensions	81 x 78 x 24 mm
Flange type	Flange without mounting element
Shaft Type	Hollow shaft
Shaft diameter D [mm]	6 6.35 9.525 10 12 12.7 14 15.875 19.05 20
Housing material	Metal/plastic, ZnAlCu1/PBT-GF30-V0
Electrical connection	Connector, M12 × 1
Environmental conditions	
Ambient temperature	-25...+85 °C
	Acc. to UL approval to +70 °C
Vibration resistance	55 Hz (1 mm)
Vibration resistance (EN 60068-2-6)	20 g; 10...3000 Hz; 50 cycles; 3 axes
Shock resistance (EN 60068-2-27)	100 g; 11 ms ½ sine; 3 × each; 3 axes
Continuous shock resistance (EN 60068-2-29)	40 g; 6 ms ½ sine; 4000 × each; 3 axes
Protection class	IP68 IP69K
MTTF	138 years acc. to SN 29500 (Ed. 99) 40 °C
Power-on indication	LED, Green
Measuring range display	LED, yellow, yellow flashing
Included in delivery	MT-QR24 mounting aid

proportional to the angle of the positioning element. The rugged sensors are wear and maintenance-free, thanks to the contactless operating principle. They convince through their excellent repeatability, resolution and linearity within a broad temperature range. The innovative technology ensures a high immunity to electromagnetic DC and AC fields.

Mounting instructions

Mounting instructions/Description

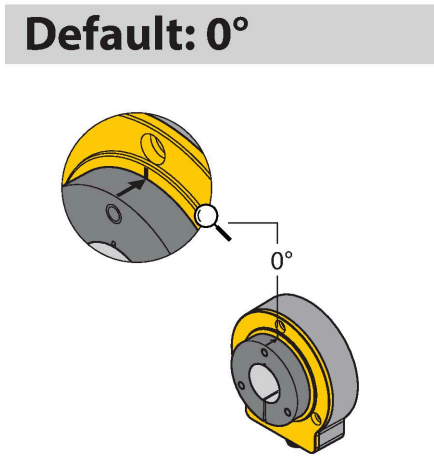
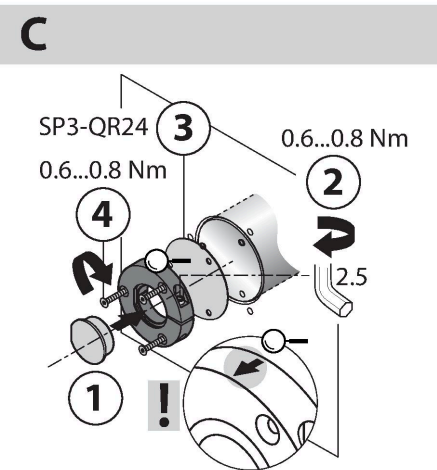
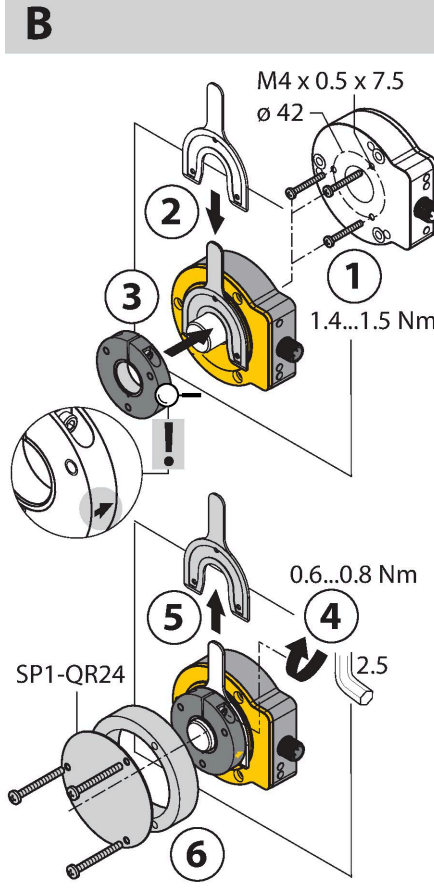
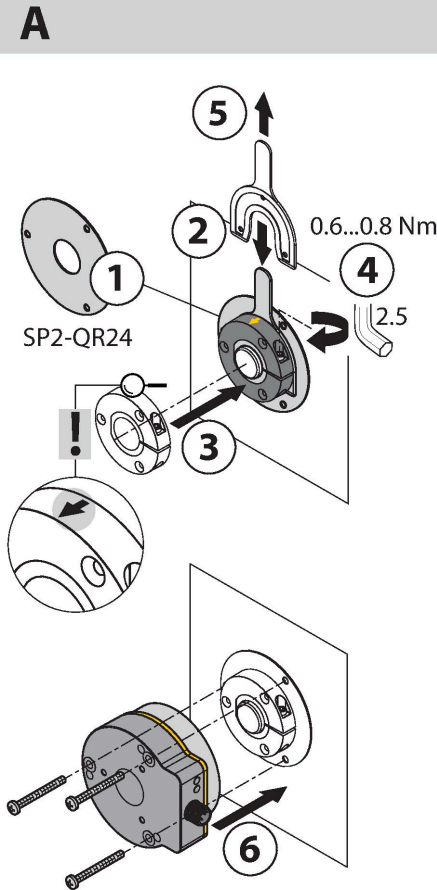

Extensive range of mounting accessories for easy adaptation to many different shaft diameters. Based on the functional principle of RLC coupling, the sensor operates absolutely wear-free and is immune to magnetized metal splinters and other interference fields. Wrong installation is hardly possible.

The adjacent figure shows the two separate units, sensor and positioning element.

Mounting option A:

First, interconnect positioning element and rotatable shaft. Then place the encoder above the rotating part in such a way that you get a tight and protected unit.

Mounting option B:

Push the encoder on the back site of the shaft and fasten it to the machine. Then clamp the positioning element to the shaft with the bracket.

Mounting option C:

If the positioning element is to be screwed on a rotating machine part, use the RA0-QR24 plug which is included in the delivery. Then tie up the bracket. Screw on the encoder via the three bores.

The separately arranged sensor and positioning element inhibit that compensating currents or damaging mechanical loads are transmitted via the shaft to the sensor. In addition, the encoder remains tight and highly protected during its entire lifespan.

The accessories enclosed in the delivery help to mount encoder and positioning element at an optimal distance from each other. LEDs indicate the switching status.

Status display via LED

green steady:

Optimal sensor supply

yellow steady:

Positioning element has reached the end of the measuring range. This is indicated by a lower signal quality.

yellow flashing:

Positioning element is outside the measuring range.

off:

Positioning element is in the measuring range.

Individual Parameterization (Teaching with Positioning Element)

Jumper between teach input Pin 8	Gnd Pin 1	Ub Pin 2	LED
2 s	Z-track zero point teaching	One-time triggering of burst function	Status LED flashes then turns steady after 2 s
10 s	CCW rotation direction	CW rotation direction	After 10 s status LED flashes fast for 2 s
15 s	-	Factory setting (z-track, CW)	After 15 s power and status LED alternate

To avoid unintended teaching, keep pin 8 potential-free.

Accessories

<p>P1-RI-QR24</p>	<p>1590921</p> <p>Positioning element, for \varnothing 20 mm shafts</p>	<p>P2-RI-QR24</p>	<p>1590922</p> <p>Positioning element, for \varnothing 14 mm shafts</p>
<p>P3-RI-QR24</p>	<p>1590923</p> <p>Positioning element, for \varnothing 12 mm shafts</p>	<p>P4-RI-QR24</p>	<p>1590924</p> <p>Positioning element, for \varnothing 10 mm shafts</p>
<p>P5-RI-QR24</p>	<p>1590925</p> <p>Positioning element, for \varnothing 6 mm shafts</p>	<p>P6-RI-QR24</p>	<p>1590926</p> <p>Positioning element, for \varnothing 3/8" shafts</p>
<p>P7-RI-QR24</p>	<p>1590927</p> <p>Positioning element, for \varnothing 1/4" shafts</p>	<p>P9-RI-QR24</p>	<p>1593012</p> <p>Positioning element for installation on \varnothing 1/2" shafts</p>
<p>P10-RI-QR24</p>	<p>1593013</p> <p>Positioning element for installation on \varnothing 5/8" shafts</p>	<p>P11-RI-QR24</p>	<p>1593014</p> <p>Positioning element for installation on \varnothing 3/4" shafts</p>
<p>P8-RI-QR24</p>	<p>1590916</p> <p>Positioning element with blanking plug for large shafts</p>	<p>M1-QR24</p>	<p>1590920</p> <p>Aluminum protecting ring, for inductive encoders RI-QR24</p>
<p>PE1-QR24</p>	<p>1590937</p> <p>Positioning element without adapter sleeve</p>	<p>RA1-QR24</p>	<p>1590928</p> <p>Adapter sleeve, for \varnothing 20 mm shafts</p>
<p>RA2-QR24</p>	<p>1590929</p> <p>Adapter sleeve, for \varnothing 14 mm shafts</p>	<p>RA3-QR24</p>	<p>1590930</p> <p>Adapter sleeve, for \varnothing 12 mm shafts</p>
<p>RA4-QR24</p>	<p>1590931</p> <p>Adapter sleeve, for \varnothing 10 mm shafts</p>	<p>RA5-QR24</p>	<p>1590932</p> <p>Adapter sleeve, for \varnothing 6 mm shafts</p>

RA6-QR24 1590933 Adapter sleeve, for Ø 3/8" shafts

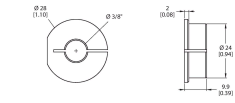

RA7-QR24 1590934 Adapter sleeve, for Ø 1/4" shafts

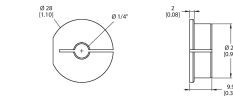

RA9-QR24 1590960 Adapter sleeve, for Ø 1/2" shafts

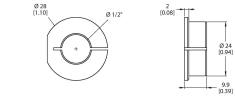

RA10-QR24 1590961 Adapter sleeve, for Ø 5/8" shafts

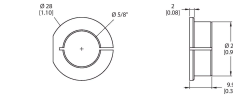

RA11-QR24 1590962 Adapter sleeve, for Ø 3/4" shafts

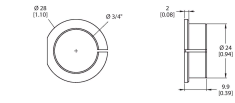

RA8-QR24 1590959 Plug for mounting option C

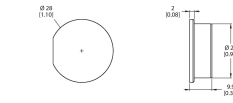

SP1-QR24 1590938 Shield plate Ø 74 mm, aluminium

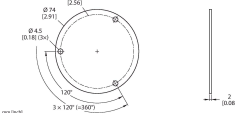

SP2-QR24 1590939 Shield plate Ø 74 mm, aluminium, with borehole for shaft feedthrough

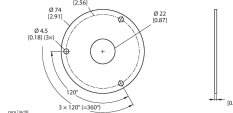

SP3-QR24 1590958 Shield plate Ø 52 mm, aluminium

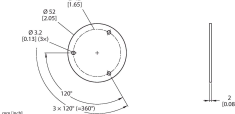

MT-QR24 1590935 Mounting aid for optimal alignment of positioning element

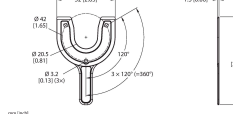

Accessories

Dimension drawing	Type	ID	
	RKC8T-2/TXL	6625142	Connection cable, M12 female connector, straight, 8-pin, cable length: 2 m, jacket material: PUR, black; cULus approval
	E-RKC 8T-264-2	U-04781	Connection cable, female M12, straight, 8-pin (twisted pairs), shielded, cable length: 2 m, sheath material: PVC, black; cULus approval; other cable lengths and qualities available, see www.turck.com

Accessories

Dimension drawing	Type	ID	
-------------------	------	----	--

TX2-Q20L60

6967117

Teach adapter for inductive encoders with 8-pin male M12 x 1, for simple programming via Easy Teach

