

Field-wireable, M12, female, angled, 8 poles, screw-/clamp contact, 30V 2A

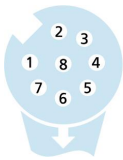

Product data	
Item description	WWAKC8K
Item-No.	8041146
Customs tariff-No.	85366990
Step-File	WWAKC8K.stp
EAN	4047106002114
Technical data	
Connector	female, angled, M12
Number of pins	8
Coding	A
Rated voltage	30V
Current load per pin (at 40°C)	2A
Insulation resistance	≥10 <sup>9</sup> Ω
Resistance	≤ 3mΩ
Ambient temperature product	-40°C...+85°C
Contact material	Metal, CuZn, gold-plated
Contact-carrier material	Plastic, PA, BK
Grip body material	Plastic, PBT/PA, BK
Coupling nut material	Metal, GD-ZN, nickel-plated
Connecting cross-section	max. 0.5 mm <sup>2</sup>
Cable outlet	6...8 mm
Connecting type	Screw-/clamp contact
Standards	IEC 61076-2-101
Degree of protection (mounted)	IP67
Mechanical life-cycle	>100 mating cycles
Degree of pollution	3
Style	angled

**Manual**

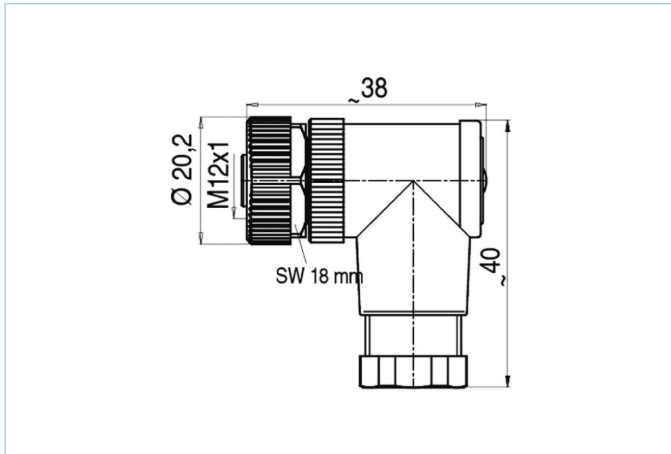
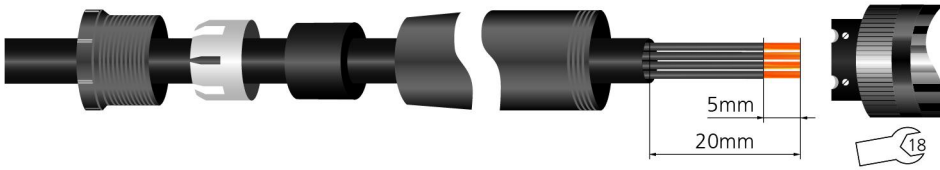

**Classification**

eCl@ss 6.0	27260702
eCl@ss 7.0	27440102
eCl@ss 8.0	27440102
eCl@ss 9.0	27440102
ETIM 5.0	EC002635
ETIM 6.0	EC002635

**Link to product**

<https://www.escha.net/en/products/standard/field-wireable-connectors/8041146>