

WLS28-2XW850XPBQ

Work Light – Linear Light

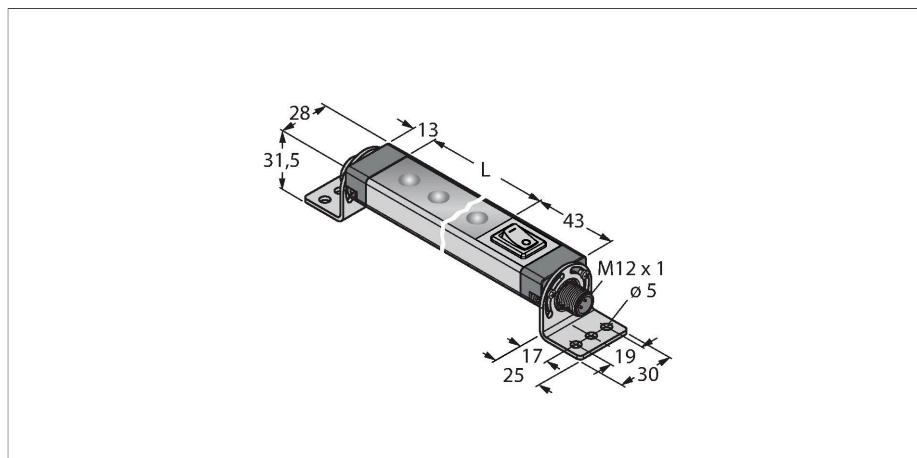

Technical data

| | |
|--------------------------------|--------------------------------|
| Type | WLS28-2XW850XPBQ |
| ID | 3087999 |
| Signal and display data | |
| Purpose | LED work light |
| Function | Linear light |
| Light type | White |
| Color temperature | 6100...+7000 K |
| Luminous flux lumen | 1950 lm |
| Aperture angle degree | 60 ° |
| Beam angle | wide beam 40-80° |
| LED service life (L70) | 50000 h |
| Dimmable | Two-stage |
| Features of color 1 | White, Permanently on, 2400 lm |
| Electrical data | |
| Operating voltage | 12...30 VDC |
| DC rated operational current | ≤ 2130 mA |
| Input power | 25.56 W |
| Mechanical data | |
| Cascadable | No |
| Design | Rectangular, WLS28-2 |
| Dimensions | 921 x 28 x 25 mm |
| Housing material | Metal, AL |
| Window material | Polycarbonate, clear |
| Electrical connection | Connector, M12 × 1, PVC |
| Number of cores | 4 |
| Ambient temperature | -40...+70 °C |
| Storage temperature | -40...+70 °C |

Features

- ON/OFF switch
- Light beam: 850 mm
- Operating voltage: 12...30 VDC
- Protection class: IP50
- Color: White
- M12 x 1 male, straight, 4-pin
- SMBWLS28RA mounting bracket included in delivery

Wiring diagram

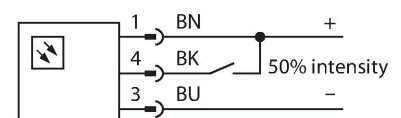

Functional principle

The low-energy LED work lights are ideally suited for industrial applications. The color temperature is between 6,000 and 7,100 Kelvin (cool white). Depending on the model, the luminous flux is 325 or 2600 lumen. Some work lights are switched on/off via supply power (10...30 VDC) and some types by means of a button directly at the LED lamp. In addition, the LED can be dimmed to 50% of its light output by activating a high signal on PIN 4, or for the variants with a switch, by means of a further switch position. On some models the light output is continuously dimmable via a PWM signal on pin 4. Cascadable variants are also available. Variants with a clear or diffuse plastic windows, as well as with an aperture angle of 25°.

Application note:

Cascading with 12 V supply allows total light length of 1.4 m. Cascading with 24 V supply allows total light length of 3.0 m. Cascading with 30 V supply allows total light length of 3.1 m.

Technical data

| | |
|------------------------|----------|
| Relative humidity | 0...90 % |
| Protection class | IP50 |
| Tests/approvals | |
| Approvals | CE, UL |

At 50% light intensity, the length specifications should be doubled.

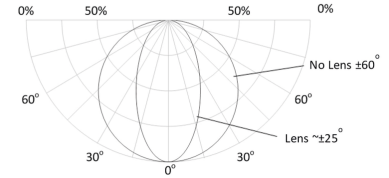

| Light Length | Typical Current | | | Max. Current |
|--------------|-----------------|--------|--------|--------------|
| | 12 VDC | 24 VDC | 30 VDC | A |
| 145 mm | 0.33 A | 0.15 A | 0.12 A | 0.4 |
| 285 mm | 0.66 A | 0.30 A | 0.24 A | 0.8 |
| 430 mm | 1.01 A | 0.46 A | 0.36 A | 1.2 |
| 570 mm | 1.36 A | 0.61 A | 0.48 A | 1.6 |
| 710 mm | 1.75 A | 0.77 A | 0.60 A | 2.0 |
| 850 mm | 2.13 A | 0.92 A | 0.73 A | 2.4 |
| 990 mm | 2.59 A | 1.08 A | 0.85 A | 2.8 |
| 1130 mm | 3.04 A | 1.24 A | 0.97 A | 3.2 |

Accessories

SMBWLSMAG 3019574

Magnetic fixture for mounting work lights and sensors, 2 pieces

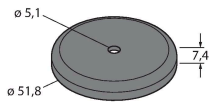

SMBWLS28RA 3015764

Mounting bracket, angled, metal, for WLS28 work lights, 5 mm drill holes, screw set included

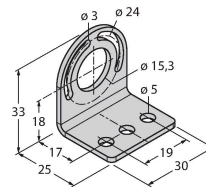

SMBWLS28SP 3088063

Snap bracket for mounting WLS28 work lights

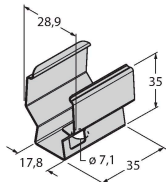

Accessories

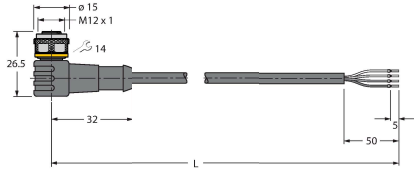
| Dimension drawing | Type | ID | |
|---|---------------|---------|---|
|  | RKC4.4T-2/TEL | 6625013 | Connection cable, M12 female connector, straight, 4-pin, cable length: 2 m, jacket material: PVC, black; cULus approval |
|  | WKC4.4T-2/TEL | 6625025 | Connection cable, M12 female connector, angled, 4-pin, cable length: 2 m, jacket material: PVC, black; cULus approval |