

Q20PRL

Photoelectric Sensor – Opposed Mode Sensor (Emitter/Receiver)

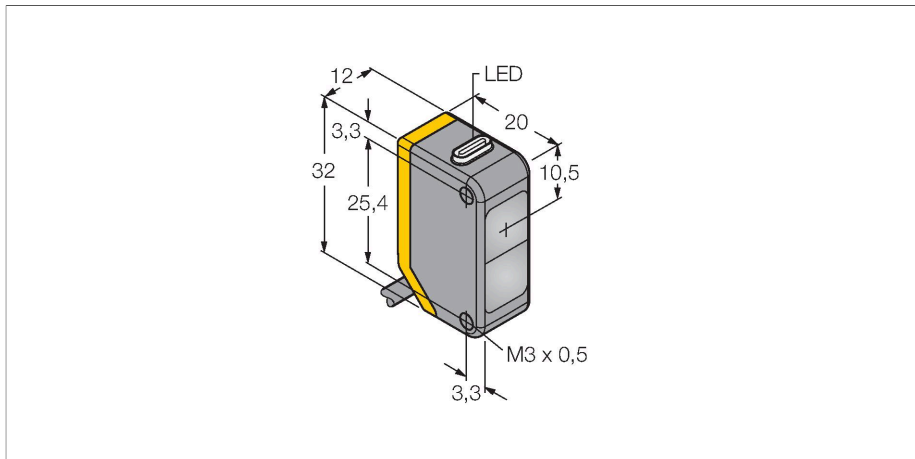

Technical data

Type	Q20PRL
ID no.	3078272
Optical data	
Function	Opposed mode sensor
Operating mode	Receiver
Range	0...20000 mm
Electrical data	
Operating voltage	10...30 VDC
Residual ripple	< 10 % U _{ss}
DC rated operational current	≤ 100 mA
No-load current	≤ 18 mA
Reverse polarity protection	yes
Output function	Complementary contact, PNP
Switching frequency	≤ 600 Hz
Readiness delay	≤ 100 ms
Response time typical	< 1 ms
Mechanical data	
Design	Rectangular, Q20
Dimensions	20 x 12 x 32 mm
Housing material	Plastic, Thermoplastic material
Lens	plastic, Acrylic
Electrical connection	Cable, 2 m, PVC
Number of cores	4
Core cross-section	0.35 mm ²
Ambient temperature	-20...+60 °C
Protection class	IP67

Features

- Cable, PVC, 2 m
- Protection class IP67
- LED all-round visible
- Operating voltage: 10...30 VDC
- PNP switching output, changeover

Wiring diagram

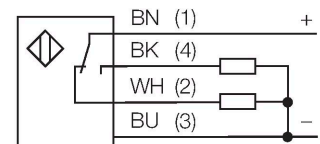

Functional principle

Opposed mode sensors consist of an emitter and receiver. They are installed opposite each other so that the light from the emitter is aimed directly at the receiver. When an object interrupts or weakens the light beam, the sensor switches. Opposed mode sensors are the most reliable photoelectric sensors for detection of opaque targets. An excellent contrast between light and dark conditions and an extremely high excess gain are typical of this sensing mode, thus allowing operation over larger distances and under difficult conditions.

Technical data

Power-on indication	LED, Green
Switching state	LED, Yellow
Error indication	LED, green, Flashing
Excess gain indication	LED, yellow, flashing
Tests/approvals	
Approvals	CE

Excess Gain Curve

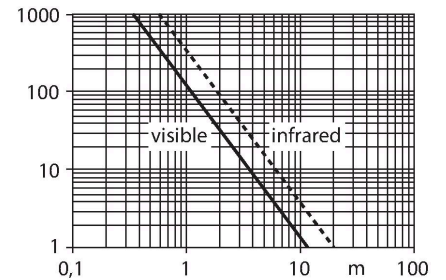

Accessories

SMBQ20H

3079041

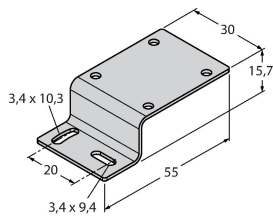

Mounting bracket, stainless steel, horizontally mounted, for Q20

SMBQ20L

3079040

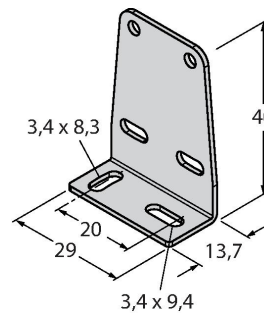

Mounting bracket, stainless steel, rectangular, for Q20

SMBQ20LV

3079042

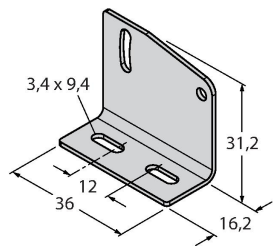

Mounting bracket, stainless steel, rectangular, for Q20

SMBQ20U

3079043

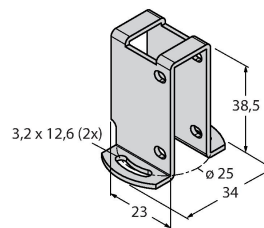

Protective housing, stainless steel, for Q20