

LEDWB75X150PW2-XQ

Vision System – Backlight

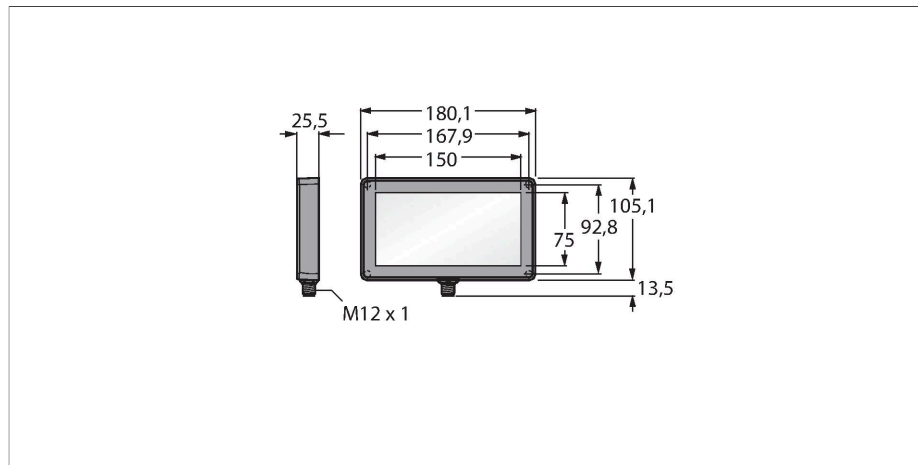

Features

- Protection class: IP67
- Color: white
- Power supply: 24 VDC
- M12 x 1 male

Wiring diagram

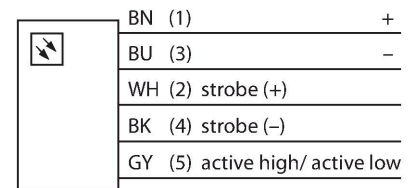

Technical data

Type	LEDWB75X150PW2-XQ
ID	3082478
Signal and display data	
Purpose	Image processing
Function	Area light
Light type	White
Color temperature	5000...+8300 K
LED service life (L70)	50000 h
Features of color 1	White
Special features	Wash down
Electrical data	
Operating voltage	24 VDC
DC rated operational current	≤ 550 mA
Max. current consumption per color	550 mA
Mechanical data	
Design	Rectangular
Dimensions	180.1 x 105.1 x 25.5 mm
Housing material	Plastic, Thermoplastic material
Window material	Acrylic, diffuse
Electrical connection	Connector, M12 × 1, PVC
Number of cores	5
Ambient temperature	0...+50 °C
Protection class	IP67
Tests/approvals	
Approvals	CE, cULus listed

Functional principle

Installed directly behind the object, opposite to the sensor. Highly diffuse surfaces and consistent brightness, with lower intensity compared to other lights.