

IVU2PTBB25

Identification – Barcode Reader — Image Sensor

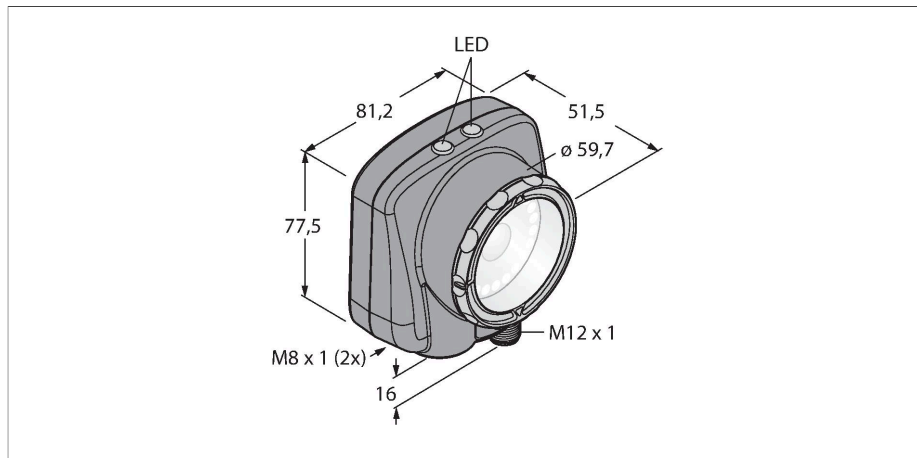

Technical data

Type	IVU2PTBB25
ID	3090793
Camera data	
Function	Barcode reader — image sensor
Resolution	752 x 480 Pixels
Light type	Blue
Brennweite	4 mm
Special features	Wash down
Electrical data	
Operating voltage	10...30 VDC
DC rated operational current	≤ 1000 mA
Communication protocol	EtherNet/IP Modbus TCP PCCC PROFINET RS232
Mechanical data	
Design	Rectangular, iVu PLUS
Dimensions	51.5 x 81.2 x 95.3 mm
Housing material	Plastic, Thermoplastic material, Black
Window material	Acrylic, clear
Electrical connection	Connector, M12 × 1, 12-wire
Display	Integriert
Ambient temperature	0...+50 °C
Protection class	IP67
Tests/approvals	
Approvals	CE

Features

- Second iVu generation
- Internal memory for 30 inspections
- 1/3" CMOS, 752x480 pixels
- Integrated ring light: Blue
- Protection class IP67
- External strobe output + 5 VDC
- External trigger input
- Lens, 25mm, M12x1
- Display: Integrated 65.5 mm LCD color display, 320 x 240 transreflective
- Operating voltage 10...30 VDC
- M12 x 1 male, 12-pin
- Three PNP/NPN switching outputs, selectable via software
- USB 2.0 host: M8 female, 4-pin
- Ethernet via M8 x 1 male, 4-pin
- Industrial Ethernet: PROFINET, EtherNet/IP, Modbus/TCP, PCCC

Wiring diagram

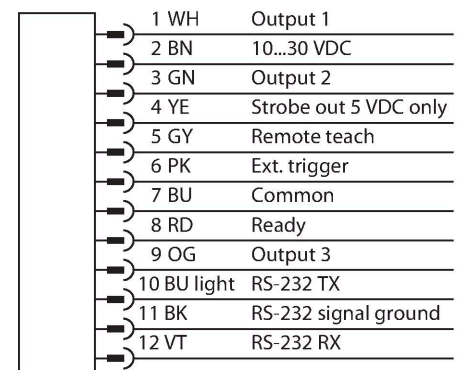

Functional principle

The second generation of the iVu-Plus offers the user advanced features and even more options in the selection of the inspections. The sensor is equipped with the same

housing and offers the same intuitive user interface and functionality of the previous iVu generation. The barcode reader consists of a camera and an integrated light (except the IVU2TBX version) able to scan up to 10 different barcodes and to transmit the data via the RS232 interface. A selection can be configured for certain barcode types such as DataMatrix (ECC 200) and a number of linear codes such as Code128, Code39, CODABAR, Interleaved 2 of 5, EAN13, EAN8, UPCE, Postnet, IMB and Pharmacode. The possibility to select between coarse and fine resolution is available with the new generation. Sensor configuration via PC is not required! Log files and firmware updates can be transmitted via the USB interface.

Mounting instructions

Mounting instructions/Description

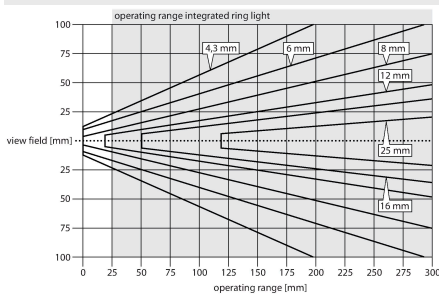

Selecting the focal length
With known object size or scan field the matching vision sensor is found simply by determining the ratio between the sensing range and the focal length. Use the graphics for selection. Here, the sensing ranges are put in relation to the field view and the lens focal length.

Accessories

SMBIVURAR

3082547

Brackets for mounting on right side

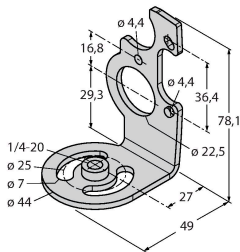

SMBIVURAL

3082546

Brackets for mounting on left side

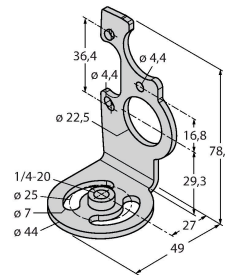

SMBIVUU

3082549

U-bracket for base mounting (incl. SMBIVUB baseplate)

