

# RSC5T-5/TXG

## Actuator and Sensor Cable, PUR – Connection Cable

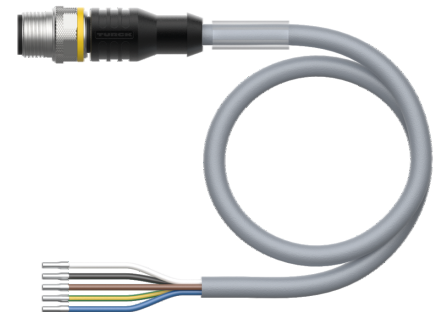
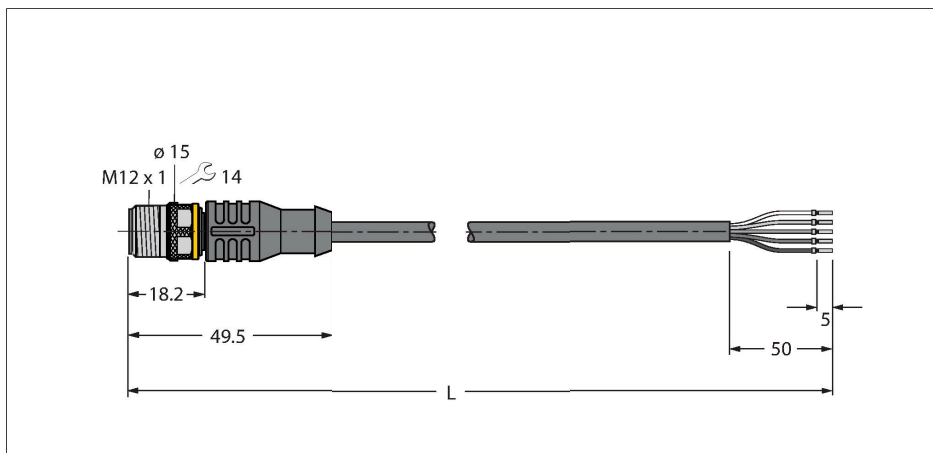

### Technical data

|                                        |                                        |
|----------------------------------------|----------------------------------------|
| Type                                   | RSC5T-5/TXG                            |
| ID                                     | 6629709                                |
| Remark to product                      | !!! Pin 5 = PE !!!                     |
| Connector A                            | Male, M12 × 1, Straight, A-coded       |
| Number of Pins                         | 4+PE                                   |
| Contacts                               | Brass, CuZn, Gold-plated               |
| Contact carriers                       | Plastic, TPU, Black                    |
| Connector body                         | Plastic, TPU, Black                    |
| Coupling nut/screw                     | Brass, CuZn, Nickel-plated             |
| Mechanical lifespan                    | > 100 Mating cycles                    |
| Pollution degree                       | 3                                      |
| Protection class                       | IP67, IP69K, Only in screwed condition |
| <b>Cable</b>                           |                                        |
| Cable diameter                         | Ø 4.8 mm ±0.20                         |
| Cable length                           | 5 m                                    |
| Cable jacket                           | PUR, Gray                              |
| Core insulation                        | PP                                     |
| Core cross-section                     | 5 x 0.34 mm <sup>2</sup>               |
| Arrangement of strands                 | 42 x 0.1 mm                            |
| Core colors                            | BN, WH, BU, BK, GNYE                   |
| <b>Electrical properties at +20 °C</b> |                                        |
| Rated voltage                          | 60 V                                   |
| Test voltage                           | 2000 V                                 |
| Current                                | 4 A                                    |
| Insulation resistance                  | > 30.5 MΩ/km                           |
| forward resistance                     | max. 57 Ω/km                           |

### Features



- Male M12, straight, 4-pin + PE
- Jacket material: PUR
- Jacket color: gray
- Suitable for drag chain use
- Resistant to chemicals, UV radiation and oils
- Flame retardant (FT2 acc. to UL 1581, IEC 60332-2-2)
- Resistant to welding sparks
- Free from halogen, silicone, PVC and LABS
- Particularly resistant to abrasion
- Protection class: IP67, IP69K
- Cable length: 5.0 m

### Cable Cross-Section

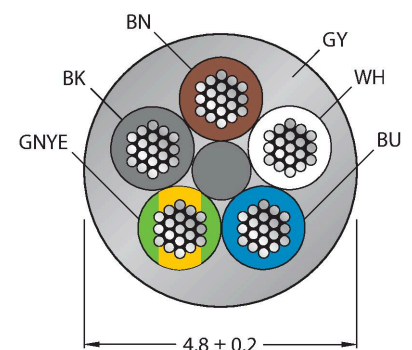

### Contact assignment

## Technical data

| Mechanical and chemical properties              |                              |
|-------------------------------------------------|------------------------------|
| Bending radius (stationary installation)        | $\geq 5 \times \varnothing$  |
| Bending radius (flexible use)                   | $\geq 10 \times \varnothing$ |
| Bending cycles                                  | $\geq 5$ million             |
| Admissible acceleration                         | max. 5 m/s <sup>2</sup>      |
| Admissible travel path, horizontal              | 5 m (at 5 m/s <sup>2</sup> ) |
| Admissible travel path, vertical                | 2 m (at 5 m/s <sup>2</sup> ) |
| Admissible traversing speed                     | 3.3 m/s                      |
| Torsional stress                                | $\pm 180$ °/m                |
| Ambient temperature range (stationary)          | -50...+80 °C                 |
| Ambient temperature range (In motion)           | -25...+80 °C                 |
| Ambient temperature during drag chain operation | -25...+60 °C                 |
| Approvals                                       | cULus                        |

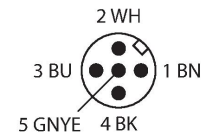

## Circuit Diagram

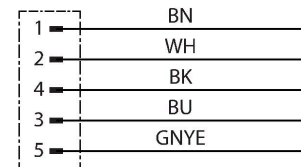

## Accessories

| TORQUE-WRENCH-SET-AS                                                                                                  | 6936170 |
|-----------------------------------------------------------------------------------------------------------------------|---------|
| Torque wrench set; handles with adjustable torque 0.4-1.0 Nm, torque wrench for M8 (SW9), fork wrench for M12 (SW 14) |         |

| BLANK-LABEL-FOR-CORDSETS-TEL-TXL                                                                                                        | 6936206 |
|-----------------------------------------------------------------------------------------------------------------------------------------|---------|
| Label for TEL and TXL cables, length: 18 mm, height: 4 mm, material: polycarbonate (PC), color: white, halogen-free and flame-retardant |         |

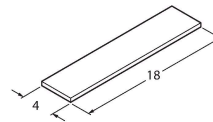

| B8151-0                                                                                                                                                                                                                 | 6904601 |
|-------------------------------------------------------------------------------------------------------------------------------------------------------------------------------------------------------------------------|---------|
| Field-wireable female connector, M12 × 1, straight, 5-pin, screw terminal connection, cable feedthrough 4.0 to 6.0 mm, core cross-section/terminal capacity 0.14 to 0.75 mm <sup>2</sup> , plastic housing, plastic nut |         |

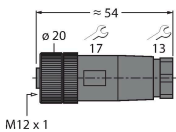

| B8251-0                                                                                                                                                                                                               | 6904602 |
|-----------------------------------------------------------------------------------------------------------------------------------------------------------------------------------------------------------------------|---------|
| Field-wireable female connector, M12 × 1, angled, 5-pin, screw terminal connection, cable feedthrough 4.0 to 6.0 mm, core cross-section/terminal capacity 0.14 to 0.75 mm <sup>2</sup> , plastic housing, plastic nut |         |

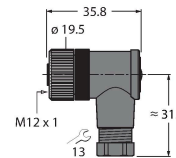

| BM8151-0                                                                                                                                                                                                              | 6935888 |
|-----------------------------------------------------------------------------------------------------------------------------------------------------------------------------------------------------------------------|---------|
| Field-wireable female connector, M12 × 1, straight, 5-pin, screw terminal connection, cable feedthrough 4.0 to 6.0 mm, core cross-section/terminal capacity 0.25 to 0.75 mm <sup>2</sup> , plastic housing, metal nut |         |

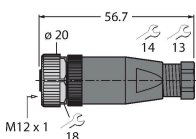

| BM8251-0                                                                                                                                                                                                            | 6935890 |
|---------------------------------------------------------------------------------------------------------------------------------------------------------------------------------------------------------------------|---------|
| Field-wireable female connector, M12 × 1, angled, 5-pin, screw terminal connection, cable feedthrough 4.0 to 6.0 mm, core cross-section/terminal capacity 0.25 to 0.75 mm <sup>2</sup> , plastic housing, metal nut |         |

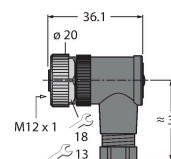

FW-ERKPM0526-SA-P-0408

100002534

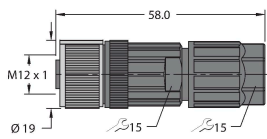

Field-wireable female connector, M12 × 1, straight, 5-pin, push-in connection, cable feedthrough 4.0 to 8.0 mm, core cross-section/terminal capacity 0.14 to 0.75 mm<sup>2</sup>, plastic housing, metal coupling nut

FW-ERKPM0516-SA-S-0408

100002285

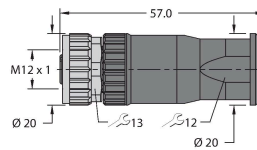

Field-wireable female connector, M12 × 1, straight, 5-pin, screw terminal connection, cable feedthrough 4.0 to 8.0 mm, core cross-section/terminal capacity 0.25 to 1.5 mm<sup>2</sup>, plastic housing, metal nut

FW-EWKPM0516-SA-S-0408

100002287

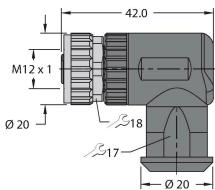

Field-wireable female connector, M12 × 1, angled, 5-pin, screw terminal connection, cable feedthrough 4.0 to 8.0 mm, core cross-section/terminal capacity 0.25 to 1.5 mm<sup>2</sup>, plastic housing, metal nut

## Accessories

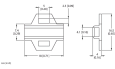
| Dimension drawing                                                                   | Type                  | ID        |                                                                                                                                                                            |
|-------------------------------------------------------------------------------------|-----------------------|-----------|----------------------------------------------------------------------------------------------------------------------------------------------------------------------------|
|  | LABEL-HOLDER-FLEX-PVC | 100048170 | PVC label holder for identification of extension cables (TEL/TXL product series); for cable diameters: min. 5 mm; dimensions 4 × 18 mm; delivery unit: 50 pcs. per package |