

# SM2A31RL W/30

## Photoelectric Sensor – Opposed Mode Sensor (Emitter/Receiver)

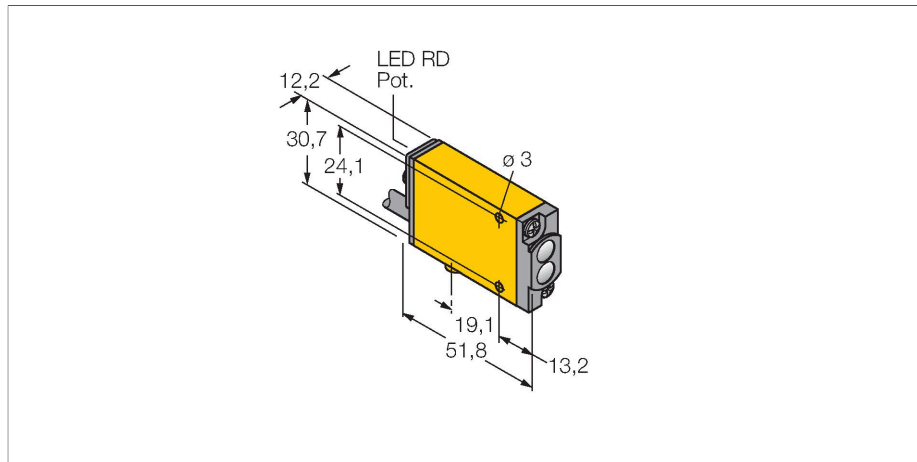

### Features

- Cable, PVC, 2 m
- Protection class IP67
- Sensitivity adjustable via potentiometer
- Alignment indicator
- Operating voltage: 24...240 VAC
- Switching output, bipolar
- Light/dark operation

### Wiring diagram

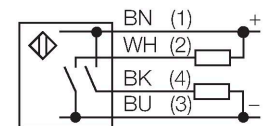

### Technical data

Type	SM2A31RL W/30
ID no.	3026562
<b>Optical data</b>	
Function	Opposed mode sensor
Operating mode	Receiver
Range	30000 mm
<b>Electrical data</b>	
Operating voltage	24...240 VAC
Output function	Relay output
Readiness delay	≤ 300 ms
Response time typical	< 2 ms
Setting option	Potentiometer
<b>Mechanical data</b>	
Design	Rectangular with thread, Mini Beam
Dimensions	Ø 18 mm
Housing material	Plastic, Thermoplastic material, Yellow
Lens	plastic, Acrylic
Electrical connection	Cable, 9 m, PVC
Number of cores	2
Ambient temperature	-20...+70 °C
Protection class	IP67
Special features	Encapsulated
Excess gain indication	LED
<b>Tests/approvals</b>	
MTTF	777 years acc. to SN 29500 (Ed. 99) 40 °C

### Functional principle

Opposed mode sensors consist of an emitter and receiver. They are installed opposite each other so that the light from the emitter is aimed directly at the receiver. When an object interrupts or weakens the light beam, the sensor switches. Opposed mode sensors are the most reliable photoelectric sensors for detection of opaque targets. An excellent contrast between light and dark conditions and an extremely high excess gain are typical of this sensing mode, thus allowing operation over larger distances and under difficult conditions.

Excess gain curve  
Excess gain in relation to the distance

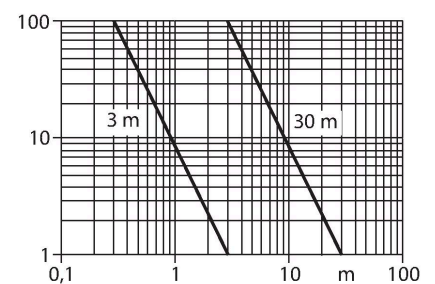

## Technical data

Approvals

CE, cURus, CSA

## Accessories

SMB18A

3033200

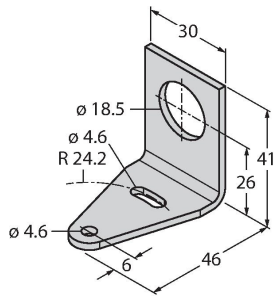

Mounting bracket, rectangular, stainless steel, for sensors with 18 mm thread

SMB18AFAM10

3012558

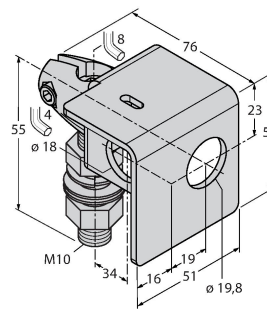

Mounting bracket, material VA 1.4401, for M10 x 1.5 thread, thread length 18 mm

SMB18SF

3052519

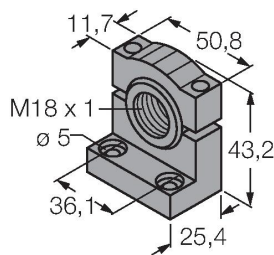

Mounting bracket, PBT black, for sensors with 18 mm thread, rotatable

SMB312B

3025519

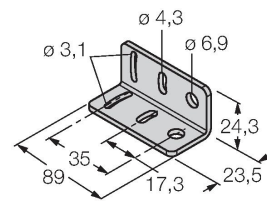

Mounting bracket, stainless steel, for MINI-BEAM NAMUR

SMB3018SC

3053952

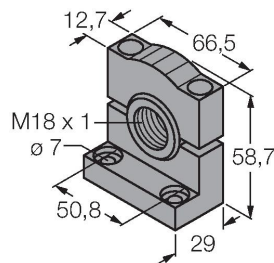

Mounting bracket, PTB black, for sensors with 18 mm thread