

SLSE30-1800P8

Light Screen for Machine Safety Applications – Emitter

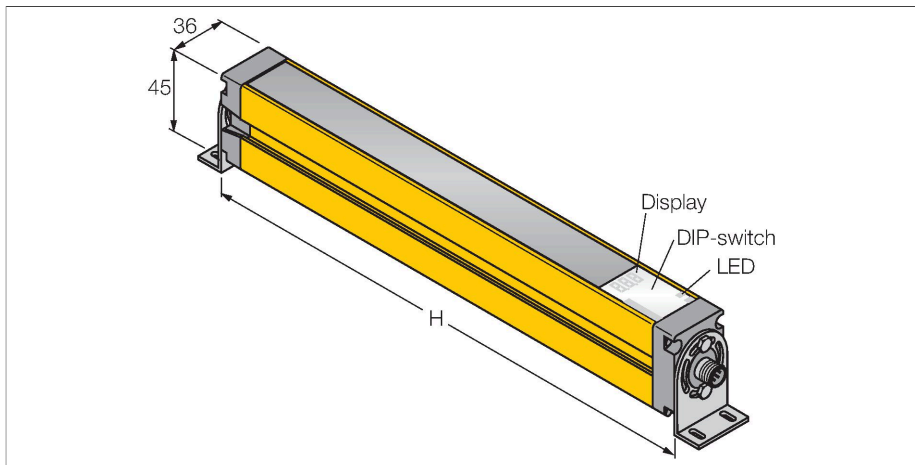

Technical data

| | |
|------------------------------|-----------------------------|
| Type | SLSE30-1800P8 |
| ID no. | 3073879 |
| Optical data | |
| Function | Light screen |
| Light type | IR |
| Wavelength | 950 nm |
| Optical resolution | 30 mm |
| Range | 100...18000 mm |
| Scan field | 1800 mm |
| Number of beams | 120 |
| With muting function | no |
| Scan Code | Adjustable |
| Electrical data | |
| Operating voltage | 20...28 VDC |
| Residual ripple | < 10 % U_{ss} |
| DC rated operational current | ≤ 100 mA |
| Short-circuit protection | yes |
| Reverse polarity protection | yes |
| Response time typical | < 32 ms |
| With restart interlock | yes |
| Blanking function | yes |
| Mechanical data | |
| Design | Rectangular, EZ-Screen |
| Dimensions | 45 x 36 x 1869 mm |
| Housing material | Metal, AL, Yellow polyester |
| Lens | plastic, Acrylic |
| Cascadable | no |

Features

- Male M12 × 1, 8-pin
- Protection class IP65
- Adjustment via DIP switch
- Operating voltage 24 VDC +15 %
- Resolution 30 mm
- Scan field 1800 mm
- All devices incl. 2 EZA-MBK-11 mounting brackets; 900 mm devices and longer additionally incl. 1 EZA-MBK-12

Wiring diagram

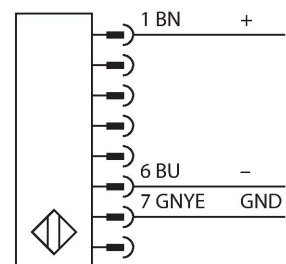

Functional principle

The high-resolution safety light screen for personnel protection consists of an emitter and a receiver. The system is optically synchronized, making the wiring between emitter and receiver redundant. The receiver's safety switching outputs are directly connected to a load relay and trigger an immediate stop of the dangerous machine cycle. Personnel safety degree type 4 acc. to IEC 61496 is fulfilled through 2 channel monitoring of the switching device and the multiple-redundant construction with mutual processor control.

Technical data

| | |
|------------------------|-------------------------------|
| Electrical connection | Cable with connector, M12 × 1 |
| Number of cores | 8 |
| Ambient temperature | 0...+50 °C |
| Protection class | IP65 |
| Power-on indication | LED, Green |
| Tests/approvals | |
| Vibration resistance | 10-55 Hz at 0.35 mm |
| Shock test | 10 g at 16 ms (6000 cycles) |
| Approvals | CE, cULus listed |

Accessories

EZA-MBK-11

3071470

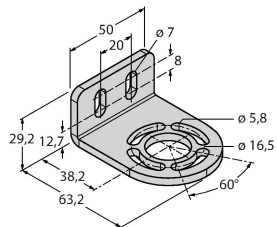

Mounting bracket, steel, black-finished, for EZ-ARRAY and EZ-SCREEN standard and cascade 14 & 30 mm

EZA-MBK-12

3071756

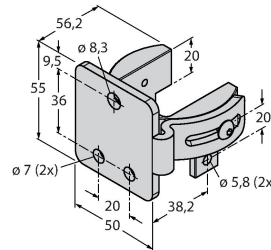

Mounting bracket, steel, black-finished, for EZ-ARRAY and EZ-SCREEN standard and cascade 14 & 30 mm



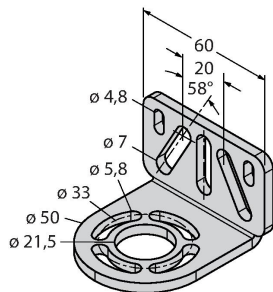

EZA-MBK-20

3072587



Mounting bracket, steel, black-finished, for EZ-ARRAY and EZ-SCREEN standard 14 & 30 mm

Accessories

| Dimension drawing | Type | ID no. | |
|--|-----------------|---------|--|
|  | QDE-815D | 3070883 | Connection cable for safety light screens, PVC, yellow, length 4.57 m, female connection, M12 x 1, 8-pin |
|  | QDE-825D | 3070884 | Connection cable for safety light screens, PVC, yellow, length 7.62 m, female connection, M12 x 1, 8-pin |
|  | QDE-850D | 3070885 | Connection cable for safety light screens, PVC, yellow, length 15.3 m, female connection, M12 x 1, 8-pin |
|  | QDE-875D | 3071466 | Connection cable for safety light screens, PVC, yellow, length 22.9 m, female connection, M12 x 1, 8-pin |
|  | QDE-8100D | 3071467 | Connection cable for safety light screens, PVC, yellow, length 30.5 m, female connection, M12 x 1, 8-pin |
| | DEE2R-81D | 3072205 | Connection cable, PVC, yellow, length: 0.31 m, female M12 x 1 - male M12, 8-pin |
| | DEE2R-83D | 3072206 | Connection cable, PVC, yellow, length: 0.91 m, female M12 x 1 - male M12, 8-pin |
| | DEE2R-88D_ | 3072635 | Connection cable, PVC, yellow, length: 2.44 m, female M12 x 1 - male M12, 8-pin |
| | DEE2R-815D | 3072207 | Connection cable, PVC, yellow, length: 4.57 m, female M12 x 1 - male M12, 8-pin |
| | DEE2R-825D | 3072208 | Connection cable, PVC, yellow, length: 7.62 m, female M12 x 1 - male M12, 8-pin |
| | DEE2R-850D | 3072209 | Connection cable, PVC, yellow, length: 15.2 m, female M12 x 1 - male M12, 8-pin |
| | DEE2R-875D | 3072210 | Connection cable, PVC, yellow, length: 22.9 m, female M12 x 1 - male M12, 8-pin |
| | DEE2R-8100D | 3072211 | Connection cable, PVC, yellow, length: 30.5 m, female M12 x 1 - male M12, 8-pin |
| | CSB-M1280M1280 | 3075375 | Y-piece, PVC, yellow, with male M12 x 1, 8-pin on 2 x 0.3 m cable, PVC, yellow, with female M12 x 1, 8-pin |
| | CSB-M1281M1281 | 3073252 | Y-piece, PVC, yellow, length: 0.3 m with male, M12 x 1, 8-pin on 2 x 0.3 m cable, PVC, yellow, with female, M12 x 1, 8-pin |
| | CSB-M1288M1281 | 3073253 | Y-piece, PVC, yellow, length: 2.5 m with male, M12 x 1, 8-pin on 2 x 0.3 m cable, PVC, yellow, with female, M12 x 1, 8-pin |
| | CSB-M12815M1281 | 3073254 | Y-piece, PVC, yellow, length: 4.6 m with male, M12 x 1, 8-pin on 2 x 0.3 m cable, |

| Dimension drawing | Type | ID no. | |
|-------------------|-----------------|---------|--|
| | | | PVC, yellow, with female, M12 x 1, 8-pin |
| | CSB-M12825M1281 | 3073255 | Y-piece, PVC, yellow, length: 7.6 m with male, M12 x 1, 8-pin on 2 x 0.3 m cable, PVC, yellow, with female, M12 x 1, 8-pin |
| | DEE2R-88D | 3094306 | Connection cable, PVC, yellow, length: 2.44 m, M12 x 1 female connector, 8-pin, on M12 x 1 male connector, 8-pin |