

Vision™ PLC+HMI

User Guide

V130-33-TR34/V130-J-TR34
V350-35-TR34/V350-J-TR34
V430-J-TR34

- 22 Digital Inputs, including 3 HSC/Shaft-encoder Inputs, 2 Analog inputs
- 8 Relay Outputs ▪ 4 high-speed npn Transistor Outputs

V130-33-R34/V130-J-R34
V350-35-R34/V350-J-R34
V430-J-R34

- 22 Digital Inputs, including 3 HSC/Shaft-encoder Inputs, 2 Analog Inputs
- 12 Relay Outputs

General Description

The products listed above are micro-PLC+HMIs, rugged programmable logic controllers that comprise built-in operating panels.

Detailed Installation Guides containing the I/O wiring diagrams for these models, technical specifications, and additional documentation are located in the Technical Library in the Unitronics website:

<https://unitronicsplc.com/support-technical-library/>



Item	V130-TR34	V130-R34	V350-TR34	V350-R34	V430J-TR34
	V130J-TR34	V130J-R34	V350J-TR34	V350J-R34	V430J-R34
On-board I/O	Model Dependent				
Screen	2.4"		3.5" Color Touch		4.3" Color Touch
Keypad	Yes		None		
Function Keys	None		Yes		
Com Port, Built-in					
RS232/485	Yes	Yes	Yes*	Yes*	Yes*
USB device, mini-B	None	None	Yes*		
Com Ports, separate order, user-installed	The user may install a CANbus port (V100-17-CAN), and one of the following: <ul style="list-style-type: none"> • RS232/RS485 port (V100-17-RS4/V100-17-RS4X) • Ethernet (V100-17-ET2) • Profibus Slave (V100-17-PB1) 				
* V430J/V350/V350J comprises both RS232/485 and USB ports; note that only one channel may be used at a time.					

Standard Kit Contents



Item	V130-TR34	V130-R34	V350-TR34	V350-R34	V430J-TR34
	V130J-TR34	V130J-R34	V350J-TR34	V350J-R34	V430J-R34
Controller	Yes				
Terminal Blocks	Yes				
Battery (installed)	Yes				
Mounting Brackets	Yes (2 parts)				Yes (4 parts)
Rubber Seal	Yes				

Alert Symbols and General Restrictions



When any of the following symbols appear, read the associated information carefully.

Symbol	Meaning	Description
	Danger	The identified danger causes physical and property damage.
	Warning	The identified danger could cause physical and property damage.
<i>Caution</i>	Caution	Use caution.

- Before using this product, the user must read and understand this document.
- All examples and diagrams are intended to aid understanding, and do not guarantee operation. Unitronics accepts no responsibility for actual use of this product based on these examples.
- Please dispose of this product according to local and national standards and regulations.
- Only qualified service personnel should open this device or carry out repairs.

	▪ Failure to comply with appropriate safety guidelines can cause severe injury or property damage.
	▪ Do not attempt to use this device with parameters that exceed permissible levels. ▪ To avoid damaging the system, do not connect/disconnect the device when power is on.

Environmental Considerations

	▪ Do not install in areas with: excessive or conductive dust, corrosive or flammable gas, moisture or rain, excessive heat, regular impact shocks or excessive vibration, in accordance with the standards given in the product's technical specification sheet. ▪ Do not place in water or let water leak onto the unit. ▪ Do not allow debris to fall inside the unit during installation.
	▪ Ventilation: 10mm space required between controller's top/bottom edges & enclosure walls. ▪ Install at maximum distance from high-voltage cables and power equipment.

Mounting

Note that figures are for illustrative purposes only.

Dimensions: V130/V350/V130J/V350J

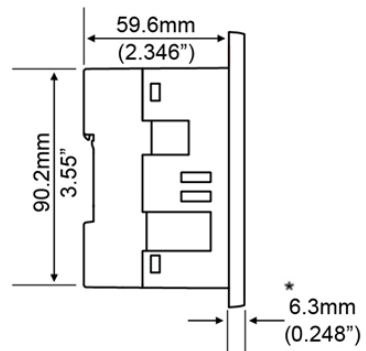
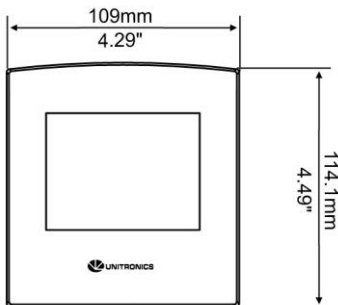

* Note that for models V130/V350, the bezel width is up to 8.4 mm (0.33").

Dimensions: V430J

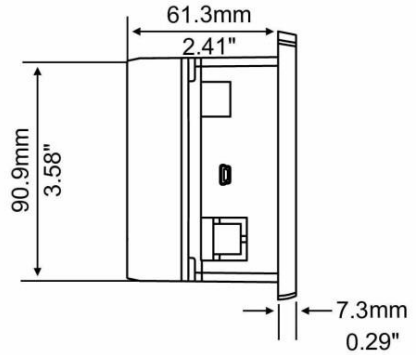
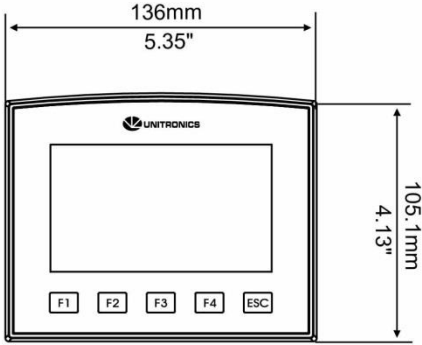

Model	Cut-out	View area
V130/V130J	92x92 mm (3.622"x3.622")	58x30.5mm (2.28"x1.2")
V350/V350J	92x92 mm (3.622"x3.622")	72x54.5mm (2.95"x2.14")
V430J	122.5x91.5 mm (4.82"x3.6")	96.4x55.2mm (3.79"x2.17")

Panel Mounting

Before you begin, note that the mounting panel cannot be more than 5 mm thick.

1. Make a panel cut-out of the appropriate size:
2. Slide the controller into the cut-out, ensuring that the rubber seal is in place.
3. Push the mounting brackets into their slots on the sides of the panel as shown in the figure below.
4. Tighten the bracket's screws against the panel. Hold the bracket securely against the unit while tightening the screw.
5. When properly mounted, the controller is squarely situated in the panel cut-out as shown in the accompanying figures.

V130/V350/V130J/V350J

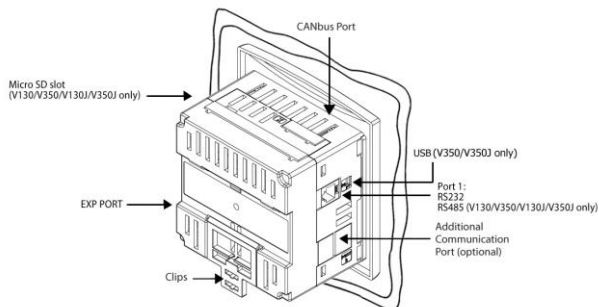

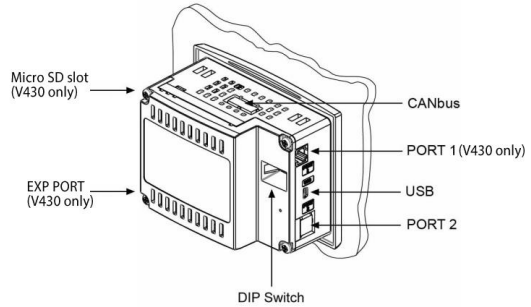
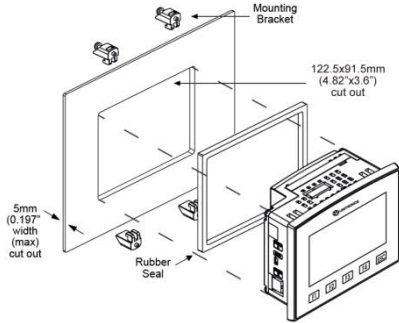
V430J**DIN-rail Mounting (V130/V350/V130J/V350J)**

1. Snap the controller onto the DIN rail as shown in the figure to the right.

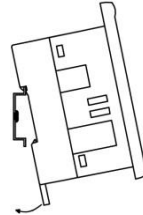

2. When properly mounted, the controller is squarely situated on the DIN-rail as shown in the figure to the right.

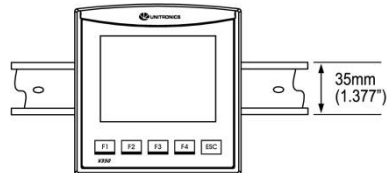
**UL Compliance**

The following section is relevant to Unitronics' products that are listed with the UL.

The following models: V130-33-R34, V130-J-R34, V130-T4-ZK1, V350-35-RA22, V350-J-RA22, V350-35-R34, V350-J-R34, V430-J-R34 are UL listed for Hazardous Locations.

The following models: V130-33-B1, V130-J-B1, V130-33-TA24, V130-J-TA24, V130-33-T38, V130-J-T38, V130-33-TR20, V130-J-TR20, V130-33-TR34, V130-J-TR34, V130-33-RA22, V130-J-RA22, V130-33-TRA22, V130-J-TRA22, V130-33-T2, V130-J-T2, V130-33-TR6, V130-J-TR6, V130-33-R34, V350-35-B1, V130-T4-ZK1, V350-J-B1, V350-35-TA24, V350-J-TA24, V350-35-T38, V350-J-T38, V350-35-TR20, V350-J-TR20, V350-35-TR34, V350-J-TR34, V350-35-TRA22, V350-J-TRA22, V350-35-T2, V350-J-T2, V350-35-TR6, V350-J-TR6, V350-S-TA24, V350-JS-TA24, V350-35-RA22,

V350-J-RA22, V350-35-R34, V430-J-B1, V430-J-TA24, V430-J-T38, V430-J-R34, V430-J-RH2, V430-J-TR34, V430-J-RA22, V430-J-TRA22, V430-J-T2, V430-J-RH6 are UL listed for Ordinary Location.

For models from series V130, V130-J, V430, that include "T4" or "J4" in the Model name, Suitable for mounting on the flat surface of Type 4X enclosure.
For examples: V130-T4-R34, V130-J4-R34, V430-J4-T2



UL Ordinary Location

In order to meet the UL ordinary location standard, panel-mount this device on the flat surface of Type 1 or 4 X enclosures

UL Ratings, Programmable Controllers for Use in Hazardous Locations,

Class I, Division 2, Groups A, B, C and D

These Release Notes relate to all Unitronics products that bear the UL symbols used to mark products that have been approved for use in hazardous locations, Class I, Division 2, Groups A, B, C and D.

-
- Caution*
- This equipment is suitable for use in Class I, Division 2, Groups A, B, C and D, or Non-hazardous locations only.
-  ▪ Input and output wiring must be in accordance with Class I, Division 2 wiring methods and in accordance with the authority having jurisdiction.
-  ▪ **WARNING—Explosion Hazard**—substitution of components may impair suitability for Class I, Division 2.
- **WARNING – EXPLOSION HAZARD** – Do not connect or disconnect equipment unless power has been switched off or the area is known to be non-hazardous.
 - **WARNING – Exposure to some chemicals may degrade the sealing properties of material used in Relays.**
 - This equipment must be installed using wiring methods as required for Class I, Division 2 as per the NEC and/or CEC.
-

Panel-Mounting

For programmable controllers that can be mounted also on panel, in order to meet the UL Haz Loc standard, panel-mount this device on the flat surface of Type 1 or Type 4X enclosures.

Relay Output Resistance Ratings

The products listed below contain relay outputs:

Programmable controllers, Models: V430-J-R34, V130-33-R34, V130-J-R34 and V350-35-R34, V350-J-R34

- When these specific products are used in hazardous locations, they are rated at 3A res.
- Except for models V430-J-R34, V130-33-R34, V130-J-R34, V130-T4-ZK1 and V350-35-R34, V350-J-R34, when these specific products are used in non-hazardous environmental conditions, they are rated at 5A res, as given in the product's specifications.

Communication and Removable Memory Storage

When products comprise either USB communication port, SD card slot, or both, neither the SD card slot nor the USB port are intended to be permanently connected, while the USB port is intended for programming only.

Removing / Replacing the battery

When a product has been installed with a battery, do not remove or replace the battery unless the power has been switched off, or the area is known to be non-hazardous.



Please note that it is recommended to back up all data retained in RAM, in order to avoid losing data when changing the battery while the power is switched off. Date and time information will also need to be reset after the procedure.

UL des zones ordinaires:

Pour respecter la norme UL des zones ordinaires, monter l'appareil sur une surface plane de type de protection 1 ou 4X

Certification UL des automates programmables, pour une utilisation en environnement à risques, Class I, Division 2, Groups A, B, C et D.

Cette note fait référence à tous les produits Unitronics portant le symbole UL - produits qui ont été certifiés pour une utilisation dans des endroits dangereux, Classe I, Division 2, Groupes A, B, C et D.

- Attention*
- Cet équipement est adapté pour une utilisation en Classe I, Division 2, Groupes A, B, C et D, ou dans Non-dangereux endroits seulement.
- 
- Le câblage des entrées/sorties doit être en accord avec les méthodes de câblage selon la Classe I, Division 2 et en accord avec l'autorité compétente.
- 
- AVERTISSEMENT: Risque d'Explosion – Le remplacement de certains composants rend caduque la certification du produit selon la Classe I, Division 2.
 - AVERTISSEMENT - DANGER D'EXPLOSION - Ne connecter pas ou ne débranche pas l'équipement sans avoir préalablement coupé l'alimentation électrique ou la zone est reconnue pour être non dangereuse.
 - AVERTISSEMENT - L'exposition à certains produits chimiques peut dégrader les propriétés des matériaux utilisés pour l'étanchéité dans les relais.
 - Cet équipement doit être installé utilisant des méthodes de câblage suivant la norme Class I, Division 2 NEC et /ou CEC.

Montage de l'écran:

Pour les automates programmables qui peuvent aussi être monté sur l'écran, pour pouvoir être au standard UL, l'écran doit être monté dans un coffret avec une surface plane de type 1 ou de type 4X.

Certification de la résistance des sorties relais

Les produits énumérés ci-dessous contiennent des sorties relais:

- Automates programmables, modèles : V430-J-R34, V130-33-R34, V130-J-R34 and V350-35-R34, V350-J-R34
- Lorsque ces produits spécifiques sont utilisés dans des endroits dangereux, ils supportent un courant de 3A charge résistive.
- Excepté les modèles: V430-J-R34, V130-33-R34, V130-J-R34, V130-T4-ZK1 et V350-35-R34, V350-J-R34 lorsque ces produits spécifiques sont utilisés dans un environnement non dangereux, ils sont évalués à 5A res, comme indiqué dans les spécifications du produit Plages de températures

Communication et de stockage amovible de mémoire (carte mémoire)

Produits comprend un port USB de communication, soit un port carte SD ou les deux, ni le port SD, ni le port USB ne sont censés être utilisés en permanence, tandis que l'USB est destiné à la programmation uniquement.

Retrait / Remplacement de la batterie

Lorsqu'un produit a été installé avec une batterie, retirez et remplacez la batterie seulement si l'alimentation est éteinte ou si l'environnement n'est pas dangereux.

Veuillez noter qu'il est recommandé de sauvegarder toutes les données conservées dans la RAM, afin d'éviter de perdre des données lors du changement de la batterie lorsque l'alimentation est coupée. Les informations sur la date et l'heure devront également être réinitialisées après la procédure

Wiring



- Do not touch live wires.



- Install an external circuit breaker. Guard against short-circuiting in external wiring.
- Use appropriate circuit protection devices.
- Unused pins should not be connected. Ignoring this directive may damage the device.
- Double-check all wiring before turning on the power supply.

Caution

- To avoid damaging the wire, do not exceed a maximum torque of 0.5 N·m (5 kgf·cm).
- Do not use tin, solder, or any substance on stripped wire that might cause the wire strand to break.
- Install at maximum distance from high-voltage cables and power equipment.

Wiring Procedure

Use crimp terminals for Use crimp terminals for wiring;

- Controllers offering a terminal block with pitch of 5mm: 26-12 AWG wire (0.13 mm² – 3.31 mm²).
- Controllers offering a terminal block with pitch of 3.81mm: 26-16 AWG wire (0.13 mm² – 1.31 mm²).

1. Strip the wire to a length of 7±0.5mm (0.270–0.300“).
2. Unscrew the terminal to its widest position before inserting a wire.
3. Insert the wire completely into the terminal to ensure a proper connection.
4. Tighten enough to keep the wire from pulling free.

- Input or output cables should not be run through the same multi-core cable or share the same wire.
- Allow for voltage drop and noise interference with I/O lines used over an extended distance. Use wire that is properly sized for the load.
- The controller and I/O signals must be connected to the same 0V signal.

I/Os

V130/V350/V130J/V350J/V430J-TR34 models comprise a total of 22 inputs and 8 relay, 4 npn outputs.

V130/V350/V130J/V350J/V430J-R34 models comprise a total of 22 inputs and 12 relay outputs.

Input functionality can be adapted as follows:

22 inputs may be used as digital inputs. They may be wired, in a group, and set to either npn or pnp via a single jumper.

In addition, according to jumper settings and appropriate wiring:

- Inputs 14 and 15 can function as either digital or analog inputs.
- Inputs 0, 2, and 4 can function as high-speed counters, as part of a shaft-encoder, or as normal digital inputs.
- Inputs 1, 3, and 5 can function as either counter reset, as part of a shaft-encoder, or as normal digital inputs.
- If inputs 0, 2 and 4 are set as high-speed counters (without reset), inputs 1, 3 and 5 can function as normal digital inputs.

Input Jumper Settings

The tables below show how to set a specific jumper to change input functionality. To access the I/O jumpers, you must open the controller according to the instructions beginning on page 12.

 Incompatible jumper settings and wiring connections may seriously damage the controller.

Digital Inputs 0-21: Set Type		
Set to	JP3 (all Inputs)	
npn (sink)	A	
pnp (source)*	B	
Inputs 14/15: Set as Digital or Analog		
Set to	JP1 (Input 14)	JP2 (Input 15)
Digital*	B	B
Analog	A	A
Analog Inputs AN0/AN1: Set Type		
Set to	JP5 (AN0)	JP4 (AN1)
Voltage	A	A
Current*	B	B

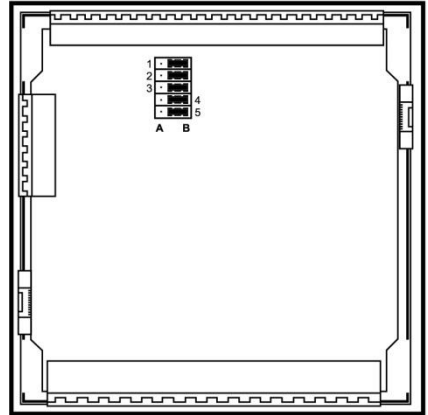

*Default settings

I/O Wiring

npn (sink) Input Wiring

Input wiring

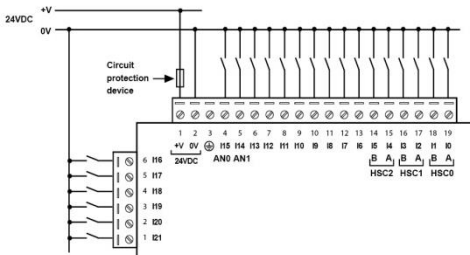

HSC input wiring

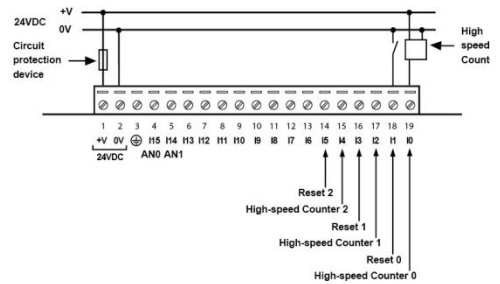

pnp (source) Input Wiring

Input wiring

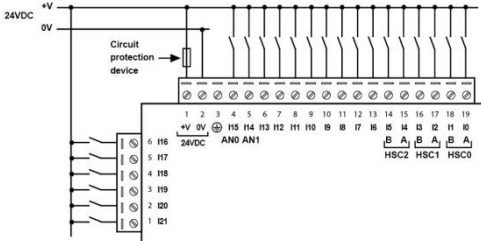

HSC input wiring

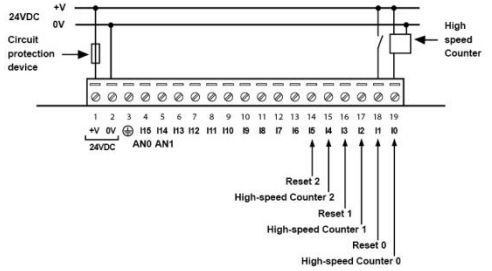

Shaft-encoder

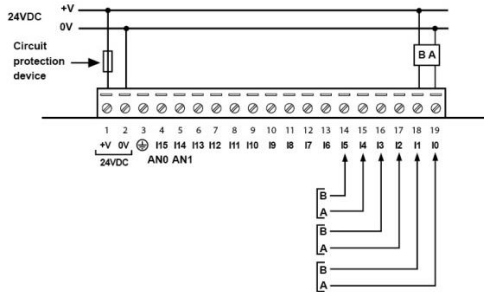

Analog Input Wiring

Analog input wiring, current (2 wire)

Analog input wiring, current (3-wire)

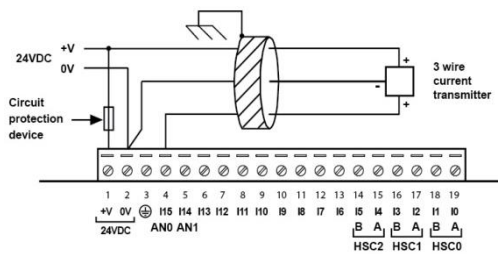
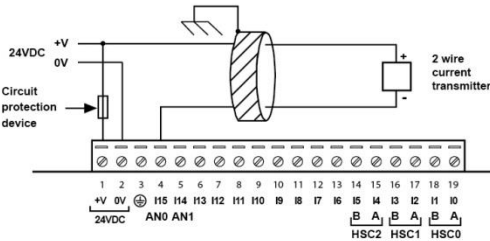

Analog input wiring, current (4-wire)

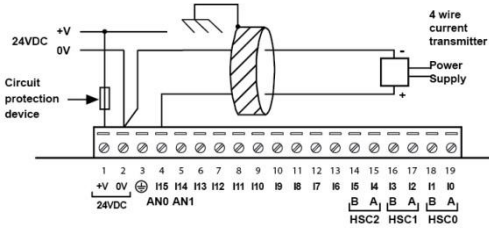

Analog input wiring, voltage

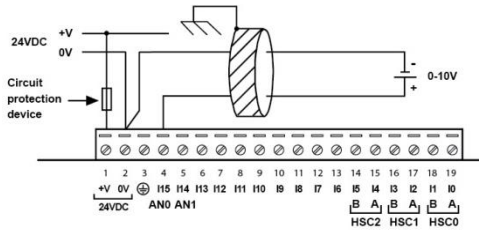

- Shields should be connected at the signal's source.
- The 0V signal of the analog input must be connected to the controller's 0V.

npn Outputs

TR34

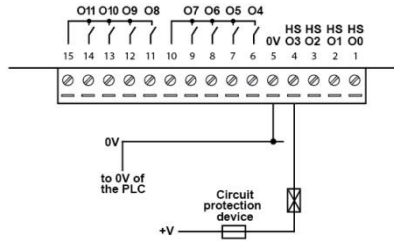

Relay Outputs

TR34

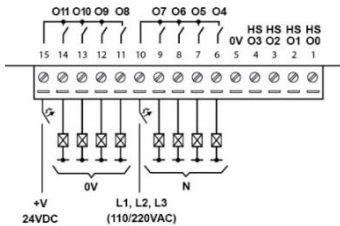

R34

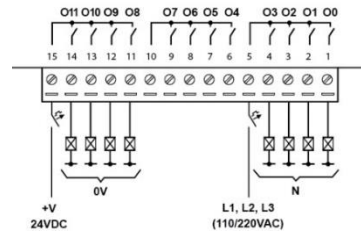

Increasing Contact Life Span

To increase the life span of the relay output contacts and protect the device from potential damage by reverse EMF, connect:

- A clamping diode in parallel with each inductive DC load
- An RC snubber circuit in parallel with each inductive AC load

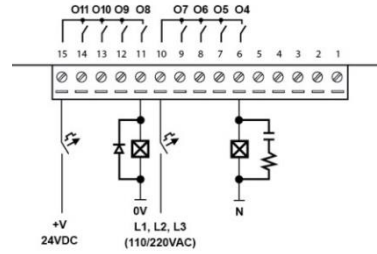

Power Supply

The controller requires an external 24VDC power supply.



- The power supply must include double insulation. Outputs must be rated as SELV/PELV/Class2/Limited Power.

- Use separate wires to connect the functional earth line (pin 3) and the 0V line (pin 2) to the system earth ground.
- Install an external circuit breaker. Guard against short-circuiting in external wiring.
- Double-check all wiring before turning on the power supply.
- Do not connect either the 'Neutral' or 'Line' signal of the 110/220VAC to device's 0V pin
- In the event of voltage fluctuations or non-conformity to voltage power supply specifications, connect the device to a regulated power supply.

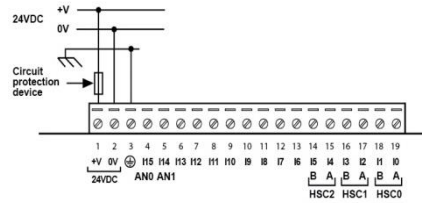

Earthing the PLC+HMI

To maximize system performance, avoid electromagnetic interference by:

- Mounting the controller on a metal panel.
- Connect each common and ground connection directly to the earth ground of your system.
- For ground wiring uses the shortest and thickest possible wire.

Communication

- **V130/ V130J**
These models comprise a built-in RS232/RS485 serial port (Port 1)
- **V430J/V350/V350J**
These models comprise built-in ports: 1 USB and 1 RS232/RS485 (Port 1).

Note that physically connecting a PC to the controller via USB suspends RS232/RS485 communications via Port 1. When the PC is disconnected, RS232/RS485 resumes.

RS232/RS485 Port



- Turn off power before making communications connections.

Caution ▪ Always use the appropriate port adapters.

- Signals are related to the controller's 0V; the same 0V is used by the power supply.

Caution ▪ The serial port is not isolated. If the controller is used with a non-isolated external device, avoid potential voltage that exceeds $\pm 10V$.

- Use RS232 to download programs from a PC, and to communicate with serial devices and applications, such as SCADA.
- Use RS485 to create a multi-drop network containing up to 32 devices.

Pinouts

The pinouts below show the PLC port signals.

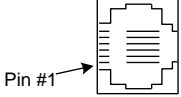
RS232		RS485**		Controller Port 
Pin #	Description	Pin #	Description	
1*	DTR signal	1	A signal (+)	
2	0V reference	2	(RS232 signal)	
3	TXD signal	3	(RS232 signal)	
4	RXD signal	4	(RS232 signal)	
5	0V reference	5	(RS232 signal)	
6*	DSR signal	6	B signal (-)	

* Standard programming cables do not provide connection points for pins 1 and 6.

** When a port is adapted to RS485, Pin 1 (DTR) is used for signal A, and Pin 6 (DSR) signal is used for signal B.

Note that it is possible to establish a PC to PLC connection using RS232 even when the PLC is set to RS485 (this eliminates the need to open the controller to set jumpers).

To do so, remove the RS485 connector (pins 1 & 6) from the PLC and connect a standard RS232 programming cable.

Note that this is possible only if DTR and DSR signals of RS232 are not used (which is the standard case).

Setting RS232/RS485 Communication Parameters, V130/V350/V130J/V350J

This port may be set to either RS232 or RS485 via jumper.

The accompanying figure shows the jumper factory default settings.

These jumpers may be used to:

- Set communications to RS485, by setting both COMM jumpers to '485'.
- Set RS485 termination, by setting both TERM jumpers to 'OFF'.

To access the jumpers, you must open the controller according to the instructions on page 12.

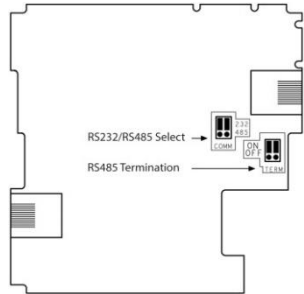

Setting RS232/RS485 Communication Parameters, V430J

This port may be set to either RS232 or RS485 via DIP switches:

The table shows the DIP switches factory default settings. Use the table to adapt the settings.

	Switch Settings					
	1	2	3	4	5	6
RS232*	ON	OFF	OFF	ON	OFF	OFF
RS485	OFF	ON	ON	OFF	OFF	OFF
RS485 with termination**	OFF	ON	ON	OFF	ON	ON

* Default factory setting

** Causes the unit to function as an end unit in an RS485 network

USB Port

Caution ▪ The USB port is not isolated.
Make sure that the PC and the controller are grounded to same potential.

The USB port may be used for programming, OS download, and PC access.

Opening the Controller

Note that the V130 photograph is for illustrative purposes only.



- Before performing these actions, touch a grounded object to discharge any electrostatic charge.
- Avoid touching the PCB board directly. Hold the PCB board by its connectors.

1. Turn off the power supply, disconnect, and dismount the controller.
2. The back cover of the controller comprises 4 screws, located in the corners. Remove the screws, and pull off the back cover.

Changing I/O Settings

After opening the controller and exposing the I/O board, you can change the jumper settings according to the table shown above.

Changing Communication Settings (V130/V350/V130J/V350J Only)

1. To access the communication jumpers, hold the I/O PCB board by its top and bottom connectors and steadily pull the board off.
2. Locate the jumpers, and then change the settings as required, according to the jumpers' settings shown on page 11.

Closing the Controller

1. Gently replace the board.
Make certain that the pins fit correctly into their matching receptacle.
Do not force the board into place; doing so may damage the controller.
2. Replace the back cover of the controller and fasten the corner screws.

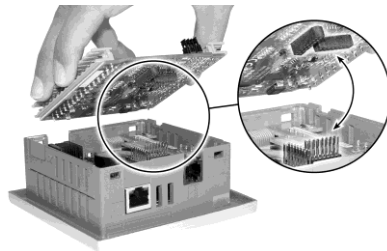

Vision™ PLC+HMI

V130-33-TR34/V130-J-TR34 V350-35-TR34/V350-J-TR34 V430-J-TR34 Technical Specifications

Order Information

Item

V130-33-TR34	PLC with Classic panel, Monochrome display 2.4"
V130-J-TR34	PLC with Flat panel, Monochrome display 2.4"
V350-35-TR34	PLC with Classic panel, Color touch display 3.5"
V350-J-TR34	PLC with Flat panel, Color touch display 3.5"
V430-J-TR34	PLC with Flat panel, Color touch display 4.3"

Power Supply

Item	V130-TR34 V130J-TR34	V350-TR34 V350J-TR34	V430J-TR34
Input voltage	24VDC		
Permissible range	20.4VDC to 28.8VDC with less than 10% ripple		
Max. current consumption	See Note 1		
npn inputs	245mA@24VDC	265mA@24VDC	265mA@24VDC
pnp inputs	170mA@24VDC	180mA@24VDC	180mA@24VDC

Notes:

- To calculate the actual power consumption, subtract the current for each unused element from the maximum current consumption value according to the values below:

	Backlight	Ethernet card	Relay Outputs (per output)
V130/J	10mA	35mA	5mA
V350/J/V430J	20mA	35mA	5mA

Digital Inputs

Number of inputs	22. See note 2	
Input type	See note 2	
Galvanic isolation	None	
Nominal input voltage	24VDC	
Input Voltage	Normal digital input	High Speed input. See Note 3
pnp (source)	0-5 VDC for Logic '0' 17-28.8 VDC for Logic '1'	0-3 VDC for Logic '0' 20.4-28.8 VDC for Logic '1'
npn (sink)	17-28.8 VDC for Logic '0' 0-5 VDC for Logic '1'	20.4-28.8 VDC for Logic '0' 0-3 VDC for Logic '1'
Input Current		
I0-5	5.4mA@24VDC	
I6-21	3.7mA@24VDC	
Input impedance		
I0-5	4.5KΩ	
I6-21	6.5KΩ	
Response Time	10ms typical, when used as normal digital input	
Input Cable length		
Normal digital Input	Up to 100 meters	
High Speed Input	Up to 50 meters, shielded, see Frequency table below	
High speed inputs	Specifications below apply when wired as HSC/shaft-encoder. See Note 2.	

Frequency, HSC		
Driver type	pnp/npn	Push-pull
Cable length (max.)		
10m	95kHz maximum	200kHz maximum
25m	50kHz maximum	200kHz maximum
50m	25kHz maximum	200kHz maximum

Frequency, Shaft-encoder		
Driver type	pnp/npn	Push-pull
Cable length (max.)		
10m	35kHz maximum	100kHz maximum
25m	18kHz maximum	100kHz maximum
50m	10kHz maximum	100kHz maximum

Duty cycle 40-60%
 Resolution 32-bit

Notes:

2. V130/V350/V130J/V350J/V430J-TR34 models comprise a total of 22 inputs and 8 relay, 4 npn outputs.

Input functionality can be adapted as follows:

22 inputs may be used as digital inputs. They may be wired, in a group, and set to either npn or pnp via a single jumper.

In addition, according to jumper settings and appropriate wiring:

- Inputs 14 and 15 can function as either digital or analog inputs.
- Inputs 0, 2, and 4 can function as high-speed counters, as part of a shaft-encoder, or as normal digital inputs.
- Inputs 1, 3, and 5 can function as either counter reset, as part of a shaft-encoder, or as normal digital inputs.
- If inputs 0, 2 and 4 are set as high-speed counters (without reset), inputs 1, 3 and 5 can function as normal digital inputs.

3. If you configure an input as high-speed, you can use an end-device that comprises push-pull drive type. In this case, the high-speed input voltage ratings for npn/pnp apply.

Analog Inputs

Number of inputs	2, according to wiring as described above in Note 2	
Input type	Multi-range inputs: 0-10V, 0-20mA, 4-20mA	
Input range	0-20mA, 4-20mA	0-10VDC
Input impedance	243Ω	>150KΩ
Maximum input rating	25mA, 6V	15V
Galvanic isolation	None	
Conversion method	Successive approximation	
Resolution (except 4-20mA)	10-bit (1024 units)	
Resolution (at 4-20mA)	204 to 1023 (820 units)	
Conversion time	One configured input is updated per scan. See Note 4	
Precision	0.9%	
Status indication	Yes – if an analog input deviates above the permissible range, its value will be 1024.	

Notes:

4. For example, if 2 inputs are configured as analog, it takes 2 scans to update all analog values.

Relay Outputs

Number of outputs	8 relay (in 2 groups). See Note 5
Output type	SPST-NO (Form A)
Galvanic isolation	By relay
Type of relay	Tyco PCN-124D3MHZ or compatible
Output current (resistive load)	3A maximum per output 8A maximum total per common
Rated voltage	250VAC/30VDC
Minimum load	1mA, 5VDC
Life expectancy	100k operations at maximum load
Response time	10ms (typical)
Contact protection	External precautions required (see Increasing Contact Life Span in the product's Installation Guide)

Notes:

- 5. Outputs 4, 5, 6, and 7 share a common signal.
Outputs 8, 9, 10, and 11 share a common signal.

Transistor Outputs

Number of outputs	4 npn (sink). See Note 6
Output type	N-MOSFET, (open drain)
Galvanic Isolation	None
Maximum output current (resistive load)	100mA per output
Rated voltage	24VDC
Maximum delay OFF to ON	1µs
Maximum delay ON to OFF	10µs
HSO freq. range with resistive load	5Hz-200kHz (at maximum load resistance of 1.5kΩ)
Maximum ON voltage drop	1VDC
Short-circuit protection	None
Voltage range	3.5V to 28.8VDC

Notes:

- 6. Outputs 0, 1, 2 and 3 share a common 0V signal.
The 0V signal of the output must be connected to the controller's 0V.

Graphic Display Screen

Item	V130-TR34	V350-TR34	V430J-TR34
	V130J-TR34	V350J-TR34	
LCD Type	STN, LCD display	TFT, LCD display	TFT, LCD display
Illumination backlight	White LED	White LED	White LED
Display resolution	128x64 pixels	320x240 pixels	480x272 pixels
Viewing area	2.4"	3.5"	4.3"
Colors	Monochrome	65,536 (16-bit)	65,536 (16-bit)
Screen Contrast	Via software (Store value to SI 7, values range: 0 to 100%)	Fixed	Fixed
Touchscreen	None	Resistive, analog	Resistive, analog
'Touch' indication	None	Via buzzer	Via buzzer
Screen brightness control	Via software (Store value to SI 9, 0 = Off, 1 = On)	Via software (Store value to SI 9, values range: 0 to 100%)	
Virtual Keypad	None	Displays virtual keyboard when the application requires data entry.	

Keypad

Item	V130-TR34 V130J-TR34	V350-TR34 V350J-TR34	V430J-TR34
Number of keys	20 keys, including 10 user-labeled keys	5 programmable function keys	
Key type	Metal dome, sealed membrane switch		
Slides	Slides may be installed in the operating panel faceplate to custom-label the keys. Refer to <i>V130 Keypad Slides.pdf</i> . A complete set of blank slides is available by separate order	Slides may be installed in the operating panel faceplate to custom-label the keys. Refer to <i>V350 Keypad Slides.pdf</i> . Two sets of slides are supplied with the controller: one set of arrow keys, and one blank set.	None

Program

Item	V130-TR34 V130J-TR34	V350-TR34 V350J-TR34	V430J-TR34
Memory size			
Application Logic	512KB	1MB	1MB
Images	128KB	6MB	12MB
Fonts	128KB	512KB	512KB

Operand type	Quantity		Symbol	Value
Item	V130-TR34 V130J-TR34	V350-TR34 V350J-TR34 V430J-TR34		
Memory Bits	4096	8192	MB	Bit (coil)
Memory Integers	2048	4096	MI	16-bit signed/unsigned
Long Integers	256	512	ML	32-bit signed/unsigned
Double Word	64	256	DW	32-bit unsigned
Memory Floats	24	64	MF	32-bit signed/unsigned
Fast Bits	1024	1024	XB	Fast Bits (coil) – not retained
Fast Integers	512	512	XI	16 bit signed/unsigned (fast, not retained)
Fast Long Integers	256	256	XL	32 bit signed/unsigned (fast, not retained)
Fast Double Word	64	64	XDW	32 bit unsigned (fast, not retained)
Timers	192	384	T	Res. 10 ms; max 99h, 59 min, 59.99s
Counters	24	32	C	32-bit
Data Tables	120K dynamic data (recipe parameters, datalogs, etc.) 192K fixed data (read-only data, ingredient names, etc) Expandable via SD card. See Removable Memory below			
HMI displays	Up to 1024			
Program scan time	20µs per 1kb of typical application	15µs per 1kb of typical application		

Removable Memory

Micro SD card	Compatible with standard SD and SDHC; up to 32GB store datalogs, Alarms, Trends, Data Tables, backup Ladder, HMI, and OS. See Note 7
---------------	---

Notes:

7. User must format via Unitronics SD tools utility.

Communication Ports

Port 1	1 channel, RS232/RS485 and USB device (V430/V350/V350J only). See Note 8
Galvanic isolation	No
Baud rate	300 to 115200 bps
RS232	
Input voltage	±20VDC absolute maximum
Cable length	15m maximum (50')
RS485	
Input voltage	-7 to +12VDC differential maximum
Cable type	Shielded twisted pair, in compliance with EIA 485
Cable length	1200m maximum (4000')
Nodes	Up to 32
USB device	
(V430/V350/V350J only)	
Port type	Mini-B, See Note 10
Specification	USB 2.0 compliant; full speed
Cable	USB 2.0 compliant; up to 3m
Port 2 (optional)	See Note 9
CANbus (optional)	See Note 9

Notes:

- This model is supplied with a serial port: RS232/RS485 (Port 1). The standard is set to either RS232 or RS485 according to jumper settings. Refer to the product's Installation Guide.
- The user may order and install one or both of the following modules:
 - An additional port (Port 2). Available port types: RS232/RS485 isolated/non-isolated, Ethernet
 - A CANbus port
 Port module documentation is available on the Unitronics website.
- Note that physically connecting a PC to the controller via USB suspends RS232/RS485 communications via Port 1. When the PC is disconnected, RS232/RS485 resumes.

I/O Expansion

	Additional I/Os may be added. Configurations vary according to module. Supports digital, high-speed, analog, weight and temperature measurement I/Os.
Local	Via I/O Expansion Port. Integrate up to 8 I/O Expansion Modules comprising up to 128 additional I/Os. Adapter required (P.N. EX-A2X).
Remote	Via CANbus port. Connect up to 60 adapters to a distance of 1000 meters from controller; and up to 8 I/O expansion modules to each adapter (up to a total of 512 I/Os). Adapter required (P.N. EX-RC1).

Miscellaneous

Clock (RTC)	Real-time clock functions (date and time)
Battery back-up	7 years typical at 25°C, battery back-up for RTC and system data, including variable data
Battery replacement	Yes. Coin-type 3V, lithium battery, CR2450

Dimensions

Item		V130-TR34	V350-TR34	V430J-TR34
		V130J-TR34	V350J-TR34	
Size	Vxxx	109 x 114.1 x 68mm (4.29 x 4.49 x 2.67")	109 x 114.1 x 68mm (4.29 x 4.49 x 2.67")	
See Note 11				
	Vxxx-J	109 x 114.1 x 66mm (4.92 x 4.49 x 2.59")	109 x 114.1 x 66mm (4.92 x 4.49 x 2.59")	136 x 105.1 x 61.3mm (5.35 x 4.13 x 2.41")
Weight		227g (8 oz)	235g (8.28 oz)	260g (9.17 oz)

Notes:

11. For exact dimensions, refer to the product's Installation Guide.

Environment

Operational temperature	0 to 50°C (32 to 122°F)
Storage temperature	-20 to 60°C (-4 to 140°F)
Relative Humidity (RH)	10% to 95% (non-condensing)
Mounting method	Panel mounted (IP65/66/NEMA4X) DIN-rail mounted (IP20/NEMA1)
Operating Altitude	2000m (6562 ft)
Shock	IEC 60068-2-27, 15G, 11ms duration
Vibration	IEC 60068-2-6, 5Hz to 8.4Hz, 3.5mm constant amplitude, 8.4Hz to 150Hz, 1G acceleration.

Vision™ PLC+HMI

V130-33-R34/V130-J-R34
V350-35-R34/V350-J-R34
V430-J-R34
Technical Specifications

Order Information

Item

V130-33-R34	PLC with Classic panel, Monochrome display 2.4"
V130-J-R34	PLC with Flat panel, Monochrome display 2.4"
V350-35-R34	PLC with Classic panel, Color touch display 3.5"
V350-J-R34	PLC with Flat panel, Color touch display 3.5"
V430-J-R34	PLC with Flat panel, Color touch display 4.3"

Power Supply

Item	V130-R34 V130J-R34	V350-R34 V350J-R34	V430J-R34
Input voltage	24VDC		
Permissible range	20.4VDC to 28.8VDC with less than 10% ripple		
Max. current consumption	See Note 1		
npn inputs	245mA@24VDC	275mA@24VDC	275mA@24VDC
pnp inputs	170mA@24VDC	200mA@24VDC	200mA@24VDC

Notes:

- To calculate the actual power consumption, subtract the current for each unused element from the maximum current consumption value according to the values below:

	Backlight	Ethernet card	Relay Outputs (per output)
V130/J	10mA	35mA	5mA
V350/J/V430J	20mA	35mA	5mA

Digital Inputs

Number of inputs	22. See note 2
Input type	See note 2
Galvanic isolation	None
Nominal input voltage	24VDC
Input Voltage	
pnp (source)	0-5 VDC for Logic '0' 17-28.8 VDC for Logic '1'
npn (sink)	17-28.8 VDC for Logic '0' 0-5 VDC for Logic '1'
Input Current	3.7mA@24VDC
Input impedance	6.5KΩ
Response Time	10ms typical, when used as normal digital input
Input Cable length	
Normal digital Input	Up to 100 meters
High Speed Input	Up to 50 meters, shielded, see Frequency table below

High speed inputs Specifications below apply when wired as HSC/shaft-encoder.
See Note 2
Frequency (max) See Note 3

Cable length (max.)	HSC	Shaft-encoder pnp	Shaft-encoder npn
10m	30kHz	20kHz	16kHz
25m	25kHz	12kHz	10kHz
50m	15kHz	7kHz	5kHz
Duty cycle	40-60%		
Resolution	32-bit		

Notes:

2. This model comprises a total of 22 inputs. Input functionality can be adapted as follows:

22 inputs may be used as digital inputs. They may be wired, in a group, and set to either npn or pnp via a single jumper.

In addition, according to jumper settings and appropriate wiring:

- Inputs 14 and 15 can function as either digital or analog inputs.
- Inputs 0, 2, and 4 can function as high-speed counters, as part of a shaft-encoder, or as normal digital inputs.
- Inputs 1, 3, and 5 can function as either counter reset, as part of a shaft-encoder, or as normal digital inputs.
- If inputs 0, 2 and 4 are set as high-speed counters (without reset), inputs 1, 3 and 5 can function as normal digital inputs.

3. pnp/npn maximum frequency is at 24VDC.

Analog Inputs

Number of inputs	2, according to wiring as described above in Note 2	
Input type	Multi-range inputs: 0-10V, 0-20mA, 4-20mA	
Input range	0-20mA, 4-20mA	0-10VDC
Input impedance	243Ω	>150KΩ
Maximum input rating	25mA, 6V	15V
Galvanic isolation	None	
Conversion method	Successive approximation	
Resolution (except 4-20mA)	10-bit (1024 units)	
Resolution (at 4-20mA)	204 to 1023 (820 units)	
Conversion time	One configured input is updated per scan. See Note 4	
Precision	0.9%	
Status indication	Yes – if an analog input deviates above the permissible range, its value will be 1024.	

Notes:

4. For example, if 2 inputs are configured as analog, it takes 2 scans to update all analog values.

Relay Outputs

Number of outputs	12 relay (in 3 groups). See Note 5
Output type	SPST-NO (Form A)
Galvanic isolation	By relay
Type of relay	Tyco PCN-124D3MHZ or compatible
Output current (resistive load)	3A maximum per output 8A maximum total per common
Rated voltage	250VAC/30VDC
Minimum load	1mA, 5VDC
Life expectancy	100k operations at maximum load
Response time	10ms (typical)
Contact protection	External precautions required (see Increasing Contact Life Span in the product's Installation Guide)

Notes:

- 5. Outputs 0, 1, 2, and 3 share a common signal.
- Outputs 4, 5, 6, and 7 share a common signal.
- Outputs 8, 9, 10, and 11 share a common signal.

Graphic Display Screen

Item	V130-R34 V130J-R34	V350-R34 V350J-R34	V430J-R34
LCD Type	STN, LCD display	TFT, LCD display	TFT, LCD display
Illumination backlight	White LED	White LED	White LED
Display resolution	128x64 pixels	320x240 pixels	480x272 pixels
Viewing area	2.4"	3.5"	4.3"
Colors	Monochrome	65,536 (16-bit)	65,536 (16-bit)
Screen Contrast	Via software (Store value to SI 7, values range: 0 to 100%)	Fixed	Fixed
Touchscreen	None	Resistive, analog	Resistive, analog
'Touch' indication	None	Via buzzer	Via buzzer
Screen brightness control	Via software (Store value to SI 9, 0 = Off, 1 = On)	Via software (Store value to SI 9, values range: 0 to 100%)	
Virtual Keypad	None	Displays virtual keyboard when the application requires data entry.	

Keypad

Item	V130-R34 V130J-R34	V350-R34 V350J-R34	V430J-R34
Number of keys	20 keys, including 10 user-labeled keys	5 programmable function keys	
Key type	Metal dome, sealed membrane switch		
Slides	Slides may be installed in the operating panel faceplate to custom-label the keys. Refer to <i>V130 Keypad Slides.pdf</i> . A complete set of blank slides is available by separate order	Slides may be installed in the operating panel faceplate to custom-label the keys. Refer to <i>V350 Keypad Slides.pdf</i> . Two sets of slides are supplied with the controller: one set of arrow keys, and one blank set.	None

Program

Item	V130-R34 V130J-R34	V350-R34 V350J-R34	V430J-R34	
Memory size				
Application Logic	512KB	1MB	1MB	
Images	128KB	6MB	12MB	
Fonts	128KB	512KB	512KB	
Operand type	Quantity		Symbol Value	
Item	V130-R34 V130J-R34	V350-R34 V350J-R34 V430J-R34	Symbol	Value
Memory Bits	4096	8192	MB	Bit (coil)
Memory Integers	2048	4096	MI	16-bit signed/unsigned
Long Integers	256	512	ML	32-bit signed/unsigned
Double Word	64	256	DW	32-bit unsigned
Memory Floats	24	64	MF	32-bit signed/unsigned
Fast Bits	1024	1024	XB	Fast Bits (coil) – not retained
Fast Integers	512	512	XI	16 bit signed/unsigned (fast, not retained)
Fast Long Integers	256	256	XL	32 bit signed/unsigned (fast, not retained)
Fast Double Word	64	64	XDW	32 bit unsigned (fast, not retained)
Timers	192	384	T	Res. 10 ms; max 99h, 59 min, 59.99s
Counters	24	32	C	32-bit
Data Tables	120K dynamic data (recipe parameters, datalogs, etc.) 192K fixed data (read-only data, ingredient names, etc) Expandable via SD card. See Removable Memory below			
HMI displays	Up to 1024			
Program scan time	20µs per 1kb of typical application	15µs per 1kb of typical application		

Removable Memory

Micro SD card Compatible with standard SD and SDHC; up to 32GB store datalogs, Alarms, Trends, Data Tables, backup Ladder, HMI, and OS.
See Note 6

Notes:

6. User must format via Unitronics SD tools utility.

Communication Ports

Port 1	1 channel, RS232/RS485 and USB device (V430/V350/V350J only). See Note 7
Galvanic isolation	No
Baud rate	300 to 115200 bps
RS232	
Input voltage	±20VDC absolute maximum
Cable length	15m maximum (50')
RS485	
Input voltage	-7 to +12VDC differential maximum
Cable type	Shielded twisted pair, in compliance with EIA 485
Cable length	1200m maximum (4000')
Nodes	Up to 32
USB device	
(V430/V350/V350J only)	
Port type	Mini-B, See Note 9
Specification	USB 2.0 compliant; full speed
Cable	USB 2.0 compliant; up to 3m
Port 2 (optional)	See Note 8
CANbus (optional)	See Note 8

Notes:

- This model is supplied with a serial port: RS232/RS485 (Port 1). The standard is set to either RS232 or RS485 according to jumper settings. Refer to the product's Installation Guide.
- The user may order and install one or both of the following modules:
 - An additional port (Port 2). Available port types: RS232/RS485 isolated/non-isolated, Ethernet
 - A CANbus port
 Port module documentation is available on the Unitronics website.
- Note that physically connecting a PC to the controller via USB suspends RS232/RS485 communications via Port 1. When the PC is disconnected, RS232/RS485 resumes.

I/O Expansion

	Additional I/Os may be added. Configurations vary according to module. Supports digital, high-speed, analog, weight and temperature measurement I/Os.
Local	Via I/O Expansion Port. Integrate up to 8 I/O Expansion Modules comprising up to 128 additional I/Os. Adapter required (P.N. EX-A2X).
Remote	Via CANbus port. Connect up to 60 adapters to a distance of 1000 meters from controller; and up to 8 I/O expansion modules to each adapter (up to a total of 512 I/Os). Adapter required (P.N. EX-RC1).

Miscellaneous

Clock (RTC)	Real-time clock functions (date and time)
Battery back-up	7 years typical at 25°C, battery back-up for RTC and system data, including variable data
Battery replacement	Yes. Coin-type 3V, lithium battery, CR2450

Dimensions

Item		V130-R34 V130J-R34	V350-R34 V350J-R34	V430J-R34
Size	Vxxx	109 x 114.1 x 68mm (4.29 x 4.49 x 2.67"). See Note 10	109 x 114.1 x 68mm (4.29 x 4.49 x 2.67"). See Note 10	
	Vxxx-J	109 x 114.1 x 66mm (4.92 x 4.49 x 2.59"). See Note 10	109 x 114.1 x 66mm (4.92 x 4.49 x 2.59"). See Note 10	136 x 105.1 x 61.3mm (5.35 x 4.13 x 2.41"). See Note 10
Weight		227g (8 oz)	245g (8.64 oz)	275g (9.7 oz)

Notes:

10. For exact dimensions, refer to the product's Installation Guide.

Environment

Operational temperature	0 to 50°C (32 to 122°F)
Storage temperature	-20 to 60°C (-4 to 140°F)
Relative Humidity (RH)	10% to 95% (non-condensing)
Mounting method	Panel mounted (IP65/66/NEMA4X) DIN-rail mounted (IP20/NEMA1)
Operating Altitude	2000m (6562 ft)
Shock	IEC 60068-2-27, 15G, 11ms duration
Vibration	IEC 60068-2-6, 5Hz to 8.4Hz, 3.5mm constant amplitude, 8.4Hz to 150Hz, 1G acceleration.

The information in this document reflects products at the date of printing. Unitronics reserves the right, subject to all applicable laws, at any time, at its sole discretion, and without notice, to discontinue or change the features, designs, materials and other specifications of its products, and to either permanently or temporarily withdraw any of the foregoing from the market.

All information in this document is provided "as is" without warranty of any kind, either expressed or implied, including but not limited to any implied warranties of merchantability, fitness for a particular purpose, or non-infringement. Unitronics assumes no responsibility for errors or omissions in the information presented in this document. In no event shall Unitronics be liable for any special, incidental, indirect or consequential damages of any kind, or any damages whatsoever arising out of or in connection with the use or performance of this information.

The tradenames, trademarks, logos and service marks presented in this document, including their design, are the property of Unitronics (1989) (R'G) Ltd. or other third parties and you are not permitted to use them without the prior written consent of Unitronics or such third party as may own them

UG_V130_350_430-TR34_R34 11/22