

QS30FF200Q

Photoelectric Sensor – Diffuse Mode Sensor with Fixed-Field Background Suppression

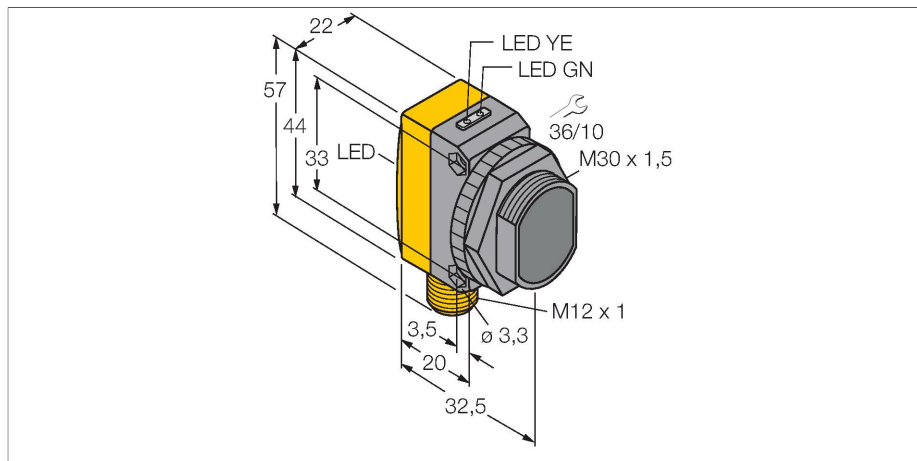

Technical data

Type	QS30FF200Q
ID no.	3073086
Optical data	
Function	Proximity switch
Operating mode	Background suppression, non-adjustable
Light type	Red
Wavelength	680 nm
Range	0...200 mm
Electrical data	
Operating voltage	10...30 VDC
Residual ripple	< 10 % U _{ss}
DC rated operational current	≤ 150 mA
No-load current	≤ 35 mA
Short-circuit protection	yes
Reverse polarity protection	yes
Output function	NO contact, PNP/NPN
Switching frequency	≤ 250 Hz
Readiness delay	≤ 100 ms
Response time typical	< 2 ms
Mechanical data	
Design	Rectangular with thread, QS30
Dimensions	Ø 30 x 35 x 22 x 57 mm
Housing material	Plastic, Thermoplastic material, Yellow
Lens	plastic, Acrylic
Electrical connection	Connectors, M12 × 1, PVC
Number of cores	5

Features

- Male M12 × 1, 5-pin
- Protection class IP67
- LED all-round visible
- Operating voltage: 10...30 VDC
- Switching output, bipolar
- Light or dark operation

Wiring diagram

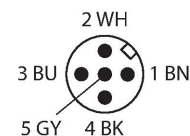
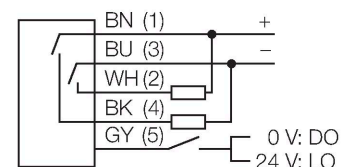

Functional principle

Diffuse mode sensors with background suppression operate with a single emitter and several receiver elements. The target position and the photoelectric structure of the sensor determine which of the receiving elements receives the most light. The sensor electronics determine whether the reflecting object is within or outside the measuring range. These sensors come with a fixed cut-off point.

Excess gain curve
Excess gain in relation to the distance

Technical data

Ambient temperature	-20...+70 °C
Protection class	IP67
Power-on indication	LED, Green
Switching state	LED, Yellow
Error indication	LED, green, Flashing
Excess gain indication	LED, yellow
Tests/approvals	
MTTF	177 years acc. to SN 29500 (Ed. 99) 40 °C
Approvals	CE

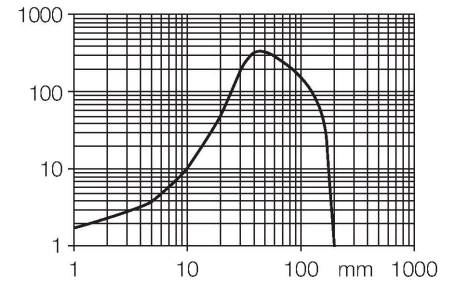

Accessories

SMB30A

3032723

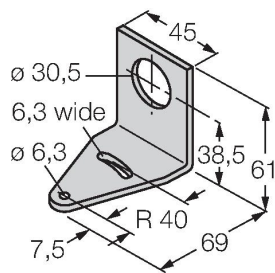

Mounting bracket, rectangular, stainless steel, for sensors with 30mm thread

SMBQS30L

3002809

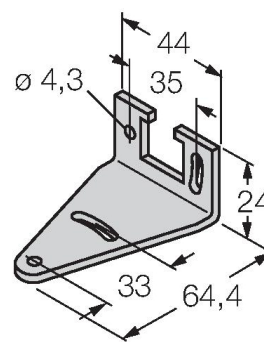

Mounting bracket, stainless steel, for QS30 series

SMB30MM

3027162

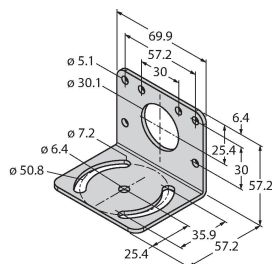

Mounting bracket, rectangular, stainless steel, for sensors with 30 mm thread, wide holes for accurate alignment

SMB30SC

3052521

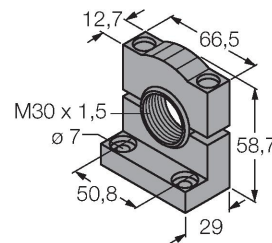

Mounting bracket, PBT black, for sensors with 30 mm thread, rotatable

Accessories

Dimension drawing	Type	ID no.	
	WKC4.5T-2/TEL	6625028	Connection cable, female M12, angled, 5-pin, cable length: 2 m, sheath material: PVC, black; cULus approval; other cable lengths and qualities available, see www.turck.com
	RKC4.5T-2/TEL	6625016	Connection cable, female M12, straight, 5-pin, cable length: 2 m, sheath material: PVC, black; cULus approval; other cable lengths and qualities available, see www.turck.com