

SM312LVMHS

Photoelectric Sensor – Retroreflective Sensor

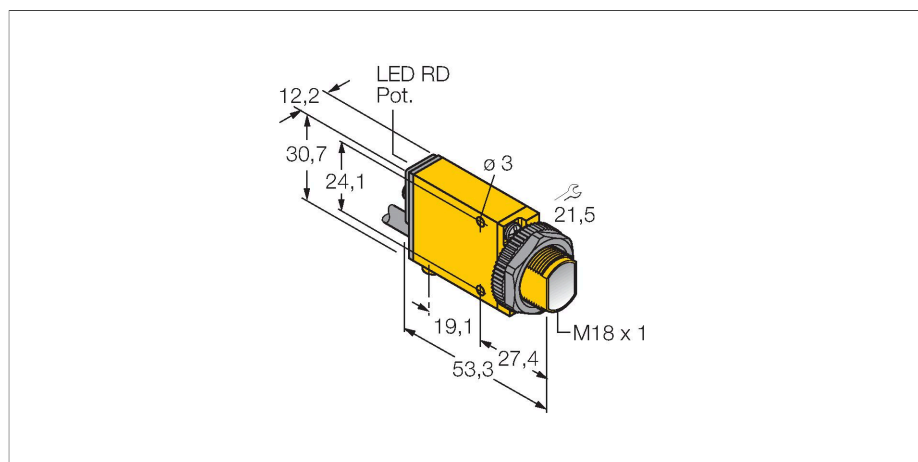

Features

- Cable, PVC, 2 m
- Protection class IP67
- Connection cable, 2 m
- Max. range 300 mm
- Reduced response time 0.3 ms
- Operating voltage: 10...30 VDC
- Switching output, bipolar
- Light/dark operation

Wiring diagram

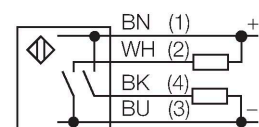

Technical data

Type	SM312LVMHS
ID no.	3026200
Optical data	
Function	Retroreflective Sensor
Operating mode	Unpolarized
Reflector included in delivery	no
Light type	Red
Wavelength	650 nm
Range	0...5000 mm
Electrical data	
Operating voltage	10...30 VDC
Residual ripple	< 10 % U _{ss}
DC rated operational current	≤ 150 mA
No-load current	≤ 25 mA
Output function	NO contact, PNP/NPN
Switching frequency	≤ 500 Hz
Readiness delay	≤ 100 ms
Response time typical	< 0.3 ms
Overcurrent release	> 220 mA
Setting option	Potentiometer
Mechanical data	
Design	Rectangular with thread, Mini Beam
Dimensions	Ø 18 x 53.3 x 12.3 x 30.7 mm
Housing material	Plastic, Thermoplastic material, Yellow
Lens	plastic, Acrylic
Electrical connection	Cable, 2 m, PVC
Number of cores	4

Functional principle

Retro-reflective sensors incorporate emitter and receiver in a single compact housing. The light beam of the emitter is directed towards a reflector which returns the light back to the receiver. An object is detected when it interrupts this beam. Retro-reflective sensors incorporate some of the advantages of opposed mode sensors (good contrast and high excess gain). Further it is merely required to install and wire a single device. A smaller sensing range and susceptibility of devices without polarisation filter can be of disadvantage when shiny objects have to be detected.

Excess gain curve
Excess gain in relation to the distance (type LV)

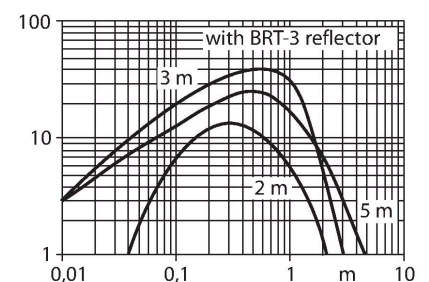

Technical data

Core cross-section	0.5 mm ²
Ambient temperature	-20...+70 °C
Protection class	IP67
Special features	Encapsulated
Switching state	LED, Red
Excess gain indication	LED, red, flashing
Tests/approvals	
Approvals	CE, cURus, CSA

Accessories

SMB18A 3033200

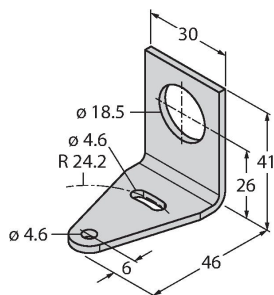

Mounting bracket, rectangular, stainless steel, for sensors with 18 mm thread

SMB18AFAM10 3012558

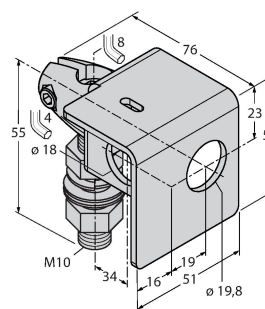

Mounting bracket, material VA 1.4401, for M10 x 1.5 thread, thread length 18 mm

SMB18SF 3052519

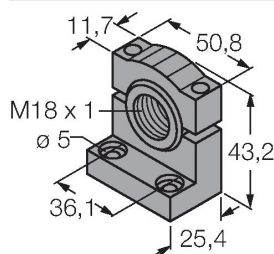

Mounting bracket, PBT black, for sensors with 18 mm thread, rotatable

SMB312B 3025519

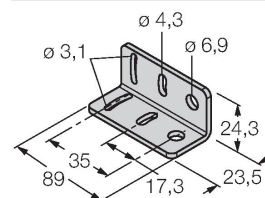

Mounting bracket, stainless steel, for MINI-BEAM NAMUR

SMB3018SC 3053952

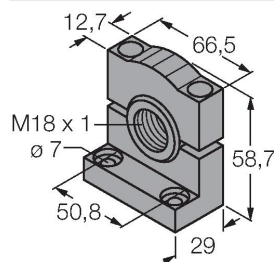

Mounting bracket, PTB black, for sensors with 18 mm thread

Accessories

Dimension drawing	Type	ID no.	
-------------------	------	--------	--

BRT-3

3016164

Round reflector, reflection coefficient 1.0, material acrylic, ambient temperature -20...+60 °C

