

UniStream® PLC

User Guide

**USC-B5-R38, USC-B10-R38,
USC-C5-R38, USC-C10-R38,
USC-B5-T42, USC-B10-T42,
USC-C5-T42, USC-C10-T42**

This guide provides basic installation information for specific UniStream® PLC models with built-in I/O. Technical specifications may be downloaded from the Unitronics website.

General Features

Unitronics' UniStream® PLCs are DIN-rail mounted Programmable Logic Controllers (PLCs) with a built-in I/O configuration.

The series is available in three versions: Pro, Standard, and Basic.

Note that a model number that includes:

- **B10/C10** refers to Pro version (e.g. USC-B10-T24)
- **B5/C5** refers to Standard version (e.g. USC-B5-RA28)
- **B3/B3** refers to Basic version (e.g. only for USC-B3-T20)

Page 2 contains a comparison table detailing the features offered by the different models. Exact features are detailed in the product specification sheets.

Power Features	<ul style="list-style-type: none">▪ Built-in Trends and Gauges, auto-tuned PID, data tables, data sampling, and Recipes▪ UniApps™: Access & edit data, monitor, troubleshoot & debug and more▪ Security: Multi-level password protection▪ Alarms: Built-in system, ANSI/ISA standards
COM Options	<ul style="list-style-type: none">▪ Built-in ports: 2 Ethernet, 1 USB host, 1 USB device port▪ Add-on ports (UAC-CB), available by separate order:<ul style="list-style-type: none">➢ 1 CANbus port may be added to all models➢ RS232/485 ports: according to model technical specifications
COM Protocols	<ul style="list-style-type: none">▪ Fieldbus: CANopen, CAN Layer2, MODBUS, EtherNetIP and more. Implement any serial RS232/485, TCP/IP, or CANbus third-party protocols via Message Composer▪ Advanced: SNMP Agent/Trap, e-mail, SMS, modems, GPRS/GSM, FTP Server/Client, Web Server, SQL, and MQTT.▪ Remote Access via any device that supports VNC.
Programming Software	All-in-One UniLogic software for hardware configuration, communications, PLC and HMI applications; free download.
HMI	All UniStream® PLCs can display HMI screens on the following devices: <ul style="list-style-type: none">• UniStream Display (USL)• UniStream Modular HMI panel (USP)• UniStream Built-in (on the panels integral to the device)• Any device screen that supports VNC

HMI	<p>HMI screens are designed in UniLogic. In addition to the HMI screens, UniStream® PLCs offer built-in HMI features, including:</p> <ul style="list-style-type: none"> • UniApps™: Access & edit data, monitor, troubleshoot, debug, and more • Security: Multi-level password protection • Alarms: Built-in system, ANSI/ISA standards
------------	---

USB Action files	<p>Programmers can create files in UniLogic and save them to a USB mass storage device, such as a flash drive. This enables the end user to implement certain actions such as to update firmware, update network settings, download applications, extract log files and more.</p>
-------------------------	---

Comparison table	Feature	B10/C10 Pro	B5/C5 Standard	B3/C3 Basic
	I/O Expansion via Uni-I/O	Yes		No
	Remote I/O Expansion via Ethernet I/O Adapter (URB)	Up to 8		1
	VFD	32		2
	MicroSD	Yes		No*
	Add-on COM modules	3		2
	System Memory	6GB	3GB	3GB
	MODBUS Slaves	Unlimited		Up to 8
	Ethernet/IP Scanners	16		1
	Ethernet/IP Adapters	32		8
	Web Server	Yes	No	No
	SQL Client	Yes	No	No
	MQTT	Yes		
	PID Loops	64		2
	Data Sampler/Trends	Yes		No
	CSV files: creating/ reading	Yes		No
	FTP, server/client	Yes		No
	Saving Data Tables to SD	Yes		No*
	Screenshots	Yes		No
	Sending email attachments	Yes		No
	USB device (programming port)	Yes		No**

* Note that B3/C3 models do not support features requiring SD cards. In addition, Alarm History is not retained after PLC reset.

** Note that B3/C3 models may be programmed only via Ethernet cable.



Before You Begin

Before installing the device, the user must:

- Read and understand this document.
- Verify the Kit Contents.

Alert Symbols and General Restrictions

When any of the following symbols appear, read the associated information carefully.

Symbol	Meaning	Description
	Danger	The identified danger causes physical and property damage.
	Warning	The identified danger could cause physical and property damage.
Caution	Caution	Use caution.

- All examples and diagrams are intended to aid understanding, and do not guarantee operation. Unitronics accepts no responsibility for actual use of this product based on these examples.
- Please dispose of this product according to local and national standards and regulations.
- This product should be installed only by qualified personnel.

- 
 - Failure to comply with appropriate safety guidelines can cause severe injury or property damage.
 - Do not attempt to use this device with parameters that exceed permissible levels.
 - Do not connect/disconnect the device when power is on.

Environmental Considerations

- 
 - Ventilation: 10mm space is required between the device top/bottom edges and the enclosure's walls
 - Do not install in areas with: excessive or conductive dust, corrosive or flammable gas, moisture or rain, excessive heat, regular impact shocks or excessive vibration, in accordance with the standards and limitations given in the product's technical specification sheet.
 - Do not place in water or let water leak onto the unit.
 - Do not allow debris to fall inside the unit during installation.
 - Install at maximum distance from high-voltage cables and power equipment.

Kit Contents

- 1 UniStream PLC
- 1 power terminal block
- 3 I/O terminal blocks (provided only with models comprising built-in I/Os)
- 1 Battery

Product Diagram

1	Output LEDs	Green / Red LEDs
2	Status LEDs	Tricolor LEDs, Green/Red/Orange From top to bottom: RUN, ERROR, USB, BATT. LOW, and FORCE. Note that LED indications are listed in the product's technical specifications.
3	DIN-rail clips	Clips at top and bottom physically support the device
4	Input LEDs	Green / Red LEDs
5	Top Door, Closed	Covers the Confirm button and the USB Host port
6	Bottom Door, Closed	Covers the internal door protecting the battery and microSD slot.

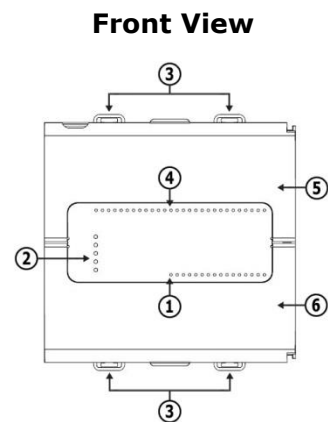

7	Uni-COM™ Jack	Connection port for Uni-COM CB modules*. Shipped covered; leave cover in place when not in use.
8	Ethernet ports	Two ports for Ethernet communications.
9	Input/Output connection points	Model-dependent. Present in models with built-in I/O configurations.
10	I/O Bus connector	(Not shown) Connection point for Uni-I/O™ modules and I/O expansion adapters, shipped covered. Leave covered when not in use.
11	CONFIRM Button	Used to implement and confirm USB Actions.
12	USB Host port	Provides the interface for external USB devices.

Top View

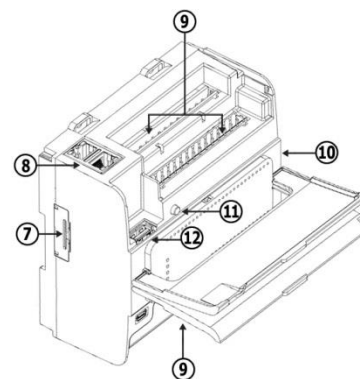

13	Internal Door, open	Open this to access the battery + microSD slot.
14	Power Supply Input	Connection point for the controller power source. Connect the Terminal Block supplied with the kit to the power cable.
15	USB Device port	Use for application download and direct PC-UniStream communication.
16	microSD Slot	Supports standard microSD cards.
17	Battery Holder	The battery is supplied installed; the user must remove the pull tab during installation.

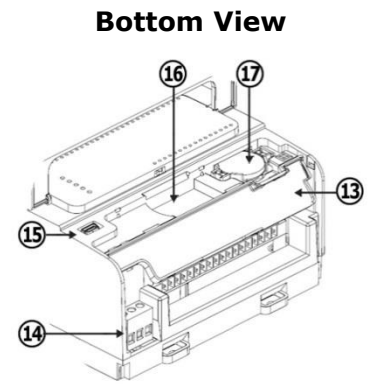

* These are available by separate order.

Installation Space Considerations

Allocate space for:

- The controller
- I/O wiring
- Access to ports, jacks, and the microSD card slot
- Any modules that will be installed; ensure you allow space to install/uninstall modules
Module dimensions and installation instructions are in the modules' specifications.

For exact dimensions, please refer to the Mechanical Dimensions shown below.

Mechanical Dimensions

Front View

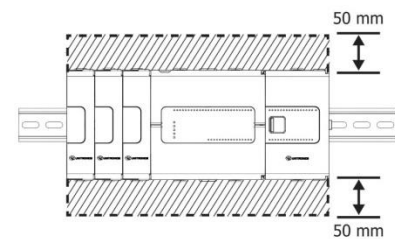
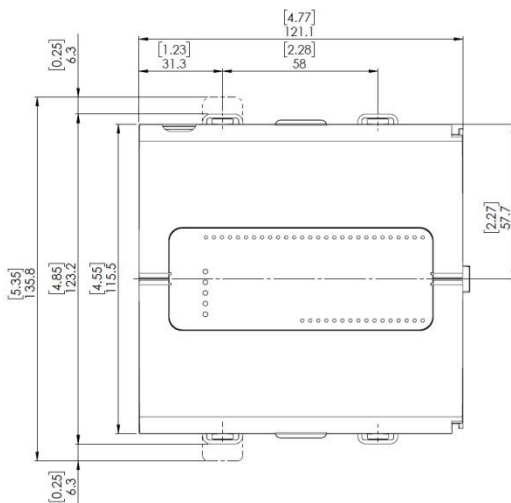

Bottom View

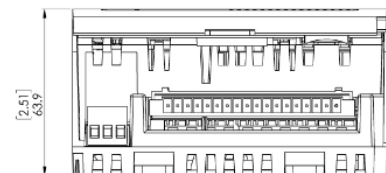

Mounting

- Note
- Mount on a standard DIN-rail.
 - Ensure that there is sufficient room on the sides of the device to allow for any I/O or COM modules.

1. Push the device onto the DIN-rail until the clips located at the top and bottom of the unit have snapped onto the DIN-rail.
2. When properly mounted, the device is squarely situated on the DIN-rail as shown below.

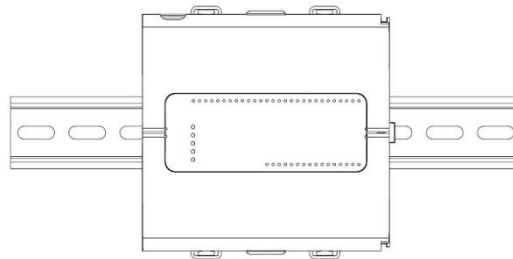

Battery: Back-up, First Use, Installation, and Replacement

Back-up

In order to preserve back-up values for RTC and system data in the event of power off, the battery must be connected.

First Use

The battery is protected by the PLC's bottom and inner door.

The battery is supplied installed inside the unit, with a plastic tab preventing contact.

Pull out this tab before using the device.

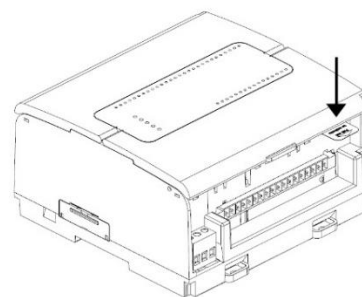

Battery Installation and Replacement

- ⚠ ▪ Use proper precautions to prevent Electro-Static Discharge (ESD) while servicing the battery.

- Caution
- To preserve back-up values for RTC and system data during battery replacement, the controller must be powered.
 - Note that disconnecting the battery halts the preservation of back-up values and causes them to be deleted.

1. Open the bottom and inner doors.
2. If there is a battery present, remove it.
3. Slide the battery into place.

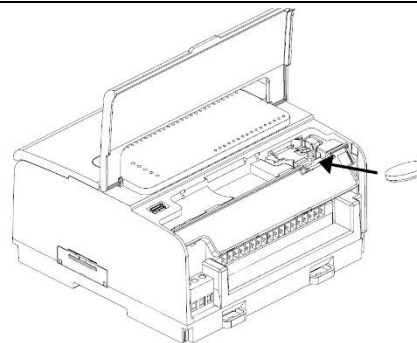

microSD Card Installation and Removal

- ⚠ Use proper precautions to prevent Electro-Static Discharge (ESD) while servicing the microSD card.

1. To install the microSD card slide it into the slot as shown in the accompanying figure, until the card clicks into place.
2. To remove the card, press it into its slot lightly, the spring ejects it.

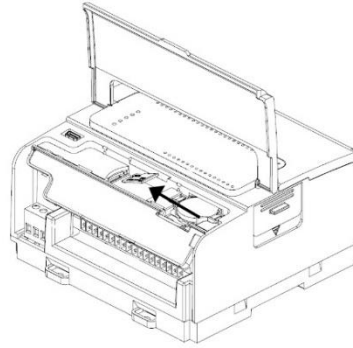

Wiring

- ⚠ This equipment is designed to operate only at SELV/PELV/Class 2/Limited Power environments.
 - All power supplies in the system must include double insulation. Power supply outputs must be rated as SELV/PELV/Class 2/Limited Power.
 - Do not connect either the 'Neutral' or 'Line' signal of the 110/220VAC to device's 0V point.
 - Do not touch live wires.
 - All wiring activities should be performed while power is OFF.
 - Use over-current protection, such as a fuse or circuit breaker, to avoid excessive currents into the power supply connection point.
 - Unused points should not be connected (unless otherwise specified). Ignoring this directive may damage the device.
 - Double-check all wiring before turning on the power supply.

- Caution
- To avoid damaging the wire, do not exceed a maximum torque of:
 - All terminal blocks except T42 outputs' terminal block: 0.5 N·m (4.4 in-lb).
 - T42 outputs' terminal block (with smaller pitch): 0.2 N·m (1.8 in-lb).
 - Do not use tin, solder, or any substance on stripped wire that might cause the wire strand to break.
 - Install at maximum distance from high-voltage cables and power equipment.

Wiring Procedure

Use crimp terminals for wiring; use 26-12 AWG wire (0.13 mm² –3.31 mm²)

1. Strip the wire to a length of 7±0.5mm (0.250–0.300 inches).
2. Unscrew the terminal to its widest position before inserting a wire.
3. Insert the wire completely into the terminal to ensure a proper connection.
4. Tighten enough to keep the wire from pulling free.

Wiring Guidelines

In order to ensure that the device will operate properly and to avoid electromagnetic interference:

- Use a metal cabinet. Make sure the cabinet and its doors are properly earthed.
- Use wires that are properly sized for the load.
- Use shielded twisted pair cables for wiring High Speed and Analog I/O signals.
Use shielded cables for wiring thermocouple and RTD signals.
In either case, do not use the cable shield as a signal common / return path.
- Route each I/O signal with its own dedicated common wire. Connect common wires at their respective common (CM) points at the controller.
- Individually connect each 0V point and each common (CM) point in the system to the power supply 0V terminal, unless otherwise specified.
- Individually connect each functional ground point (⏏) to the earth of the system (preferably to the metal cabinet chassis).
Use the shortest and thickest wires possible: less than 1m (3.3') in length, minimum thickness 14 AWG (2 mm²).
- Connect the power supply 0V to the earth of the system.
- Earthing the cables' shield:
 - Connect the cable shield to the earth of the system (preferably to the metal cabinet chassis). Note that the shield must be connected only at one end of the cable; it is recommended to earth the shield at the PLC-side.
 - Keep shield connections as short as possible.
 - Ensure shield continuity when extending shielded cables.

NOTE For detailed information, refer to the document System Wiring Guidelines, located in the Technical Library in the Unitronics' website.

Wiring the Power Supply

The controller requires an external power supply.

- ⚠ ▪ In the event of voltage fluctuations or non-conformity to voltage power supply specifications, connect the device to a regulated power supply.

Connect the +V and 0V terminals as shown in the accompanying figure.

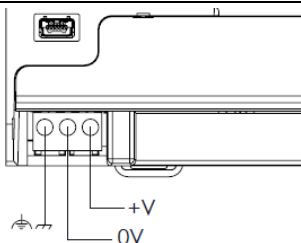

Connecting Ports

- Ethernet **CAT-5e shielded cable with RJ45 connector**
- USB Device **Use a standard USB cable, Type mini-B**
- USB Host **Standard USB Type-A plug**

Note that below, the letters “xx” that is used in the model numbers means that the section refers both to B5/C5 and B10/C10 models.

I/O Connection Points

The IOs for these models are arranged in three groups of fifteen points each, as shown in the figures to the right.

Top groups

Input connection points

Bottom group

Output connection points

The function of certain I/Os may be adapted via wiring and software settings.

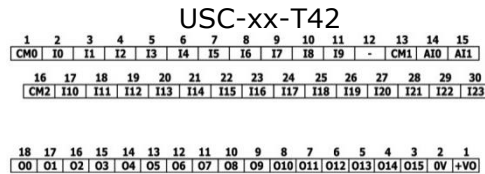
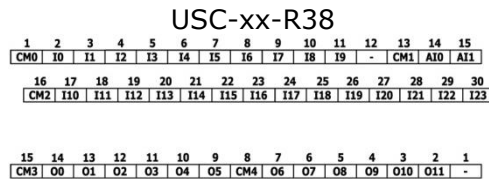

Wiring the Digital Inputs

The digital inputs are arranged in two isolated groups:

- I0-I9 share common CM0
- I10-I23 share common CM2

Each group may be wired together as sink or source.

Inputs I10-I17 can be configured as either normal digital inputs or as high speed inputs that can receive high speed pulse signals from sensors or shaft encoders.

High Speed Input Modes

Following are the different pin assignments for the high speed channels:

	Channel 1		Channel 2	
	I10	I11	I12	I13
Quadrature	Phase A	Phase B	Phase A	Phase B
Pulse+Direction	Pulse	Direction	Pulse	Direction
Pulse	Pulse	Normal digital	Pulse	Normal digital

	Channel 3		Channel 4	
	I14	I15	I16	I17
Quadrature	Phase A	Phase B	Phase A	Phase B
Pulse+Direction	Pulse	Direction	Pulse	Direction
Pulse	Pulse	Normal digital	Pulse	Normal digital

NOTE ▪ Input modes are set both by wiring and software.

Input wiring, sink

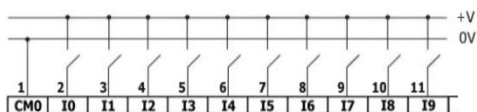

Input wiring, source

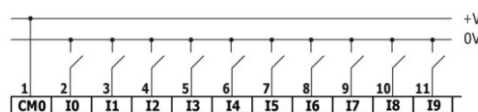

High Speed Input wiring, sink

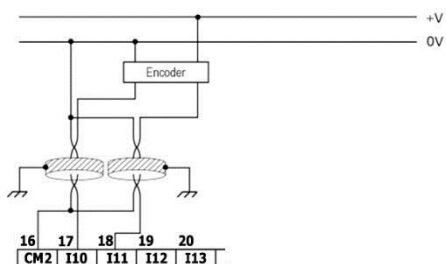

High Speed Input wiring, source

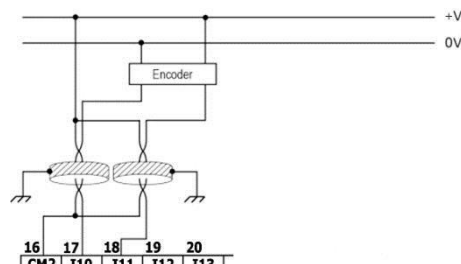

NOTE Use sink input wiring to connect a sourcing (pnp) device.
Use source input wiring to connect a sinking (npn) device.

Wiring the Analog Inputs

Both inputs share the common point CM1.

NOTI ▪ The inputs are not isolated.

- Each input offers two modes: voltage or current. You can set each input independently.
- The mode is determined by the hardware configuration within the software application.
- Note that if, for example, you wire the input to current, you must also set it to current in the software application.

Voltage

Differential

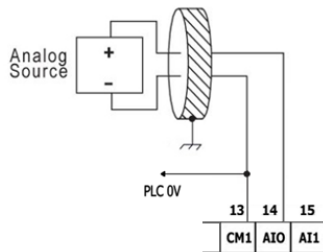

Single-ended

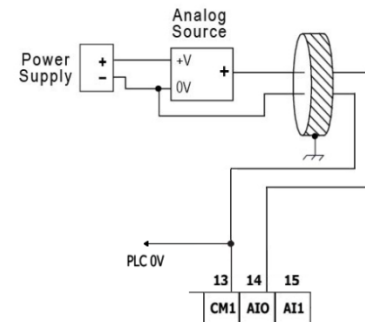

Current

2-wire

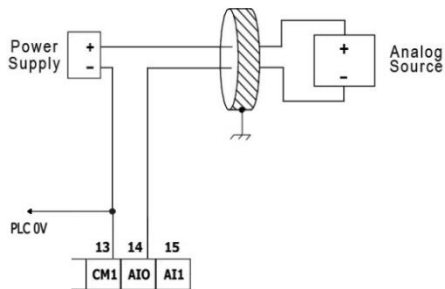

3-wire

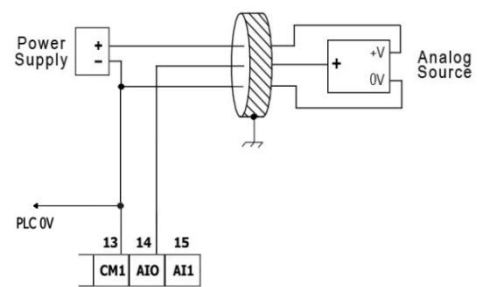

4-wire

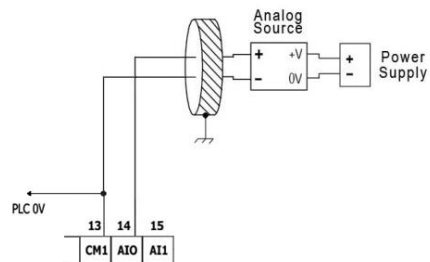

Wiring the Relay Outputs (USC-xx-R38)

- ⚠ To avoid risk of fire or property damage, always use a limited current source or connect a current limiting device in series with the relay contacts

The relay outputs are arranged in two isolated groups:

O0-O5 share the common return CM3.

O6-O11 share the common return CM4.

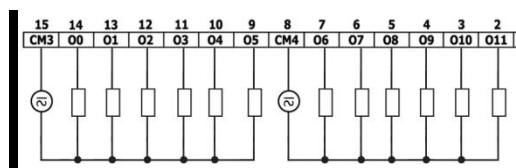

Increasing Contact Life Span

To increase the life span of the relay contacts and protect the controller from potential damage by reverse EMF, connect:

- a clamping diode in parallel with each inductive DC load,
- a RC snubber circuit in parallel with each inductive AC load

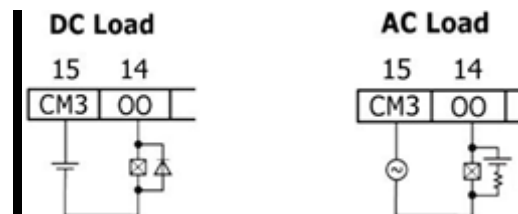

Wiring the Source Transistor Outputs (USC-xx-T42)

Output's power supply

The use of any of the outputs requires an external 24VDC power supply as shown in the accompanying figure.

Outputs

Connect the +VO and 0VO terminals as shown in the accompanying figure.

O0-O15 share common return 0VO.

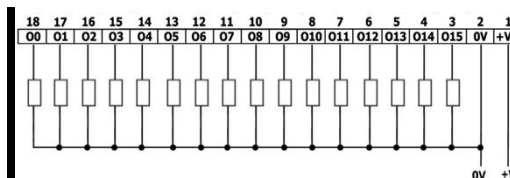

Installing Uni-I/O™ & Uni-COM™ Modules

Refer to the Installation Guides provided with these modules.

- ⚠ Turn off system power before connecting or disconnecting any modules or devices.
- Use proper precautions to prevent Electro-Static Discharge (ESD).

Uninstalling the Controller

1. Disconnect the power supply.
2. Remove all wiring and disconnect any installed devices according to the device's installation guide.
3. Unscrew and remove the mounting brackets, taking care to support the device to prevent it from falling during this procedure.

UL Compliance

The following models are UL listed for Ordinary Location:

- USC followed by - followed by B3 or B5 or B10 or C3 or C5 or C10,
- followed by B1 or TR22 or T24 or RA28 or TA30 or R38 or T42 or R20 or T20.

Communication and Removable Memory Storage

When products comprise either USB communication port, SD card slot, or both, neither the SD card slot nor the USB port are intended to be permanently connected, while the USB port is intended for programming only.

Removing / Replacing the battery

When a product has been installed with a battery, do not remove or replace the battery unless the power has been switched off, or the area is known to be non-hazardous.

Please note that it is recommended to back up all data retained in RAM, in order to avoid losing data when changing the battery while the power is switched off. Date and time information will also need to be reset after the procedure.

Communication et de stockage amovible de mémoire (carte mémoire)

Produits comprend un port USB de communication, soit un port carte SD ou les deux, ni le port SD, ni le port USB ne sont censés être utilisés en permanence, tandis que l'USB est destiné à la programmation uniquement.

Retrait / Remplacement de la batterie

Lorsqu'un produit a été installé avec une batterie, retirez et remplacez la batterie seulement si l'alimentation est éteinte ou si l'environnement n'est pas dangereux.

Veillez noter qu'il est recommandé de sauvegarder toutes les données conservées dans la RAM, afin d'éviter de perdre des données lors du changement de la batterie lorsque l'alimentation est coupée. Les informations sur la date et l'heure devront également être réinitialisées après la procédure.

UniStream[®] PLC

Technical Specifications

**USC-B5-R38, USC-B10-R38,
USC-C5-R38, USC-C10-R38,
USC-B5-T42, USC-B10-T42,
USC-C5-T42, USC-C10-T42**

Unitronics' UniStream[®] PLCs are DIN-rail mounted Programmable Logic Controllers (PLCs) with a built-in I/O configuration.

UniStream connects directly to UniCloud, Unitronics' IIoT cloud platform using built-in UniCloud connectivity. More information about UniCloud is available at www.unitronics.cloud.

Model numbers in this document

USC - B 5 - R38

	R38	<ul style="list-style-type: none"> • 24 x Digital inputs, 24VDC, sink/source, including 4 High speed counter input channels ⁽¹⁾ • 2 x Analog inputs, 0÷10V / 0÷20mA, 12 bits • 12 x Relay outputs
	T42	<ul style="list-style-type: none"> • 24 x Digital inputs, 24VDC, sink/source, including 4 High speed counter input channels ⁽¹⁾ • 2 x Analog inputs, 0÷10V / 0÷20mA, 12 bits • 16 x Transistor outputs, pnp, including 2 PWM output channels
	5	Standard
	10	Pro, offers additional features, detailed below
	B	With UniCloud enabled functionality
	C	With built-in 5 years UniCloud start-up subscription with no additional payment required for this period.

Installation Guides are available in the Unitronics Technical Library at www.unitronicsplc.com.

Power Supply	USC-xx-R38	USC-xx-T42
Input voltage	24VDC	24VDC
Permissible range	20.4VDC to 28.8VDC	20.4VDC to 28.8VDC
Max. current consumption	0.46A@24VDC	0.38A@24VDC
Isolation	None	

General	
I/O support	Up to 2,048 I/O points
Built-in I/O	According to model
Local Uni-I/O™ support	Up to 8 I/O modules can be connected directly to the controller. You can connect up to 88 I/O modules to a single controller using Local I/O Expansion adapters ⁽²⁾ . For complete details refer to Local I/O Expansion adapters technical specification.
Remote I/O	Up to 8 UniStream Remote I/O Adapters (URB)

Communication ports		
Built-in COM ports	Specifications are provided below in the section Communications	
Add-on Ports	Add up to 3 ports to a single controller using Uni-COM™ UAC-CB Modules ⁽³⁾ .	
Internal memory	Standard (B5/C5)	Pro (B10/C10)
	RAM: 512MB ROM: 3GB system memory 1GB user memory	RAM: 1GB ROM: 6GB system memory 2GB user memory
Ladder memory	1 MB	
External memory	microSD or microSDHC card Size: up to 32GB, Data Speed: up to 200Mbps	
Bit operation	0.13 μs	
Battery	Model: 3V CR2032 Lithium battery ⁽⁴⁾ Battery lifetime: 4 years typical, at 25°C Battery Low detection and indication (via BATT. LOW indicator and via System Tag).	

Communication (Built-in Ports)

Ethernet port	
Number of ports	2
Port type	10/100 Base-T (RJ45)
Auto crossover	Yes
Auto negotiation	Yes
Isolation voltage	500VAC for 1 minute
Cable	Shielded CAT5e cable, up to 100 m (328 ft)
USB device ⁽⁵⁾	
Number of ports	1
Port type	Mini-B
Data rate	USB 2.0 (480Mbps)
Isolation	None
Cable	USB 2.0 compliant; < 3 m (9.84 ft)
USB host	
Number of ports	1
Port type	Type A
Data rate	USB 2.0 (480Mbps)
Isolation	None
Cable	USB 2.0 compliant; < 3 m (9.84 ft)
Over current protection	Yes

Digital Inputs	
Number of inputs	24
Type	Sink or Source
Isolation voltage	
Input to bus	500VAC for 1 minute
Input to input	None
Nominal voltage	I0-I9, I18-I23: 24VDC @ 6mA I10-I17: 24VDC @ 8mA
Input voltage	
Sink/Source	On state: 15-30VDC, 4mA min. Off state: 0-5VDC, 1mA max.
Nominal impedance	I0-I9, I18-I23: 4kΩ I10-I17: 3kΩ
Filter	I0-I9, I18-I23: 6ms typical I10-I17: 5.5μs, 50μs, 0.5ms, 6ms, 12ms
High speed inputs ⁽¹⁾	
Frequency / Period	Pulse/Direction mode: 90kHz max. / 11.1μs min (t_p in the Pulse/Dir Mode figure below). Quadrature mode: 80kHz max. / 12.5μs min (t_p in the Quadrature Mode figure below).
Pulse width	Pulse/Direction mode: 5.1μs min. for each state (t_w in Pulse/Dir Mode figure below). Quadrature mode: 2.5μs min. for each state (t_w in Quadrature Mode figure below).
Cable	Shielded twisted pair

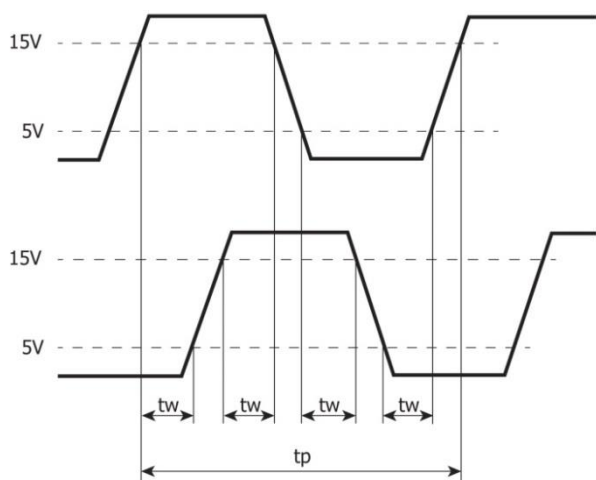

Quadrature Mode

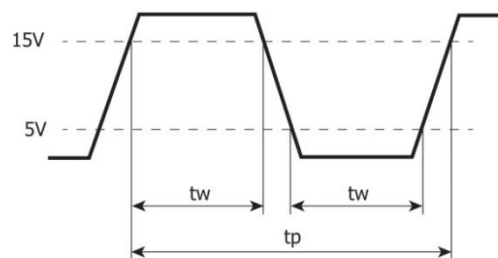

Pulse/Direction mode

Analog Inputs					
Number of inputs	2				
Input range ⁽⁶⁾ ⁽⁷⁾	Input Type	Nominal Values		Over-range Values *	
	0 ÷ 10VDC	0 ≤ Vin ≤ 10VDC		10 < Vin ≤ 10.15VDC	
	0 ÷ 20mA	0 ≤ Iin ≤ 20mA		20 < Iin ≤ 20.3mA	
	* Overflow ⁽⁸⁾ is declared when an input value exceeds the Over-range boundary.				
Absolute maximum rating	±30V (Voltage), ±30mA (Current)				
Isolation	None				
Conversion method	Successive approximation				
Resolution	12 bits				
Accuracy (25°C / -20°C to 55°C)	±0.3% / ±0.9% of full scale				
Input impedance	541kΩ (Voltage), 248Ω (Current)				
Noise rejection	10Hz, 50Hz, 60Hz, 400Hz				
Step response ⁽⁹⁾ (0 to 100% of final value)	Smoothing	Noise Rejection Frequency			
		400Hz	60Hz	50Hz	10Hz
	None	2.7ms	16.86ms	20.2ms	100.2ms
	Weak	10.2ms	66.86ms	80.2ms	400.2ms
	Medium	20.2ms	133.53ms	160.2ms	800.2ms
	Strong	40.2ms	266.86ms	320.2ms	1600.2ms
Update time ⁽⁹⁾	Noise Rejection Frequency		Update Time		
	400Hz		5ms		
	60Hz		4.17ms		
	50Hz		5ms		
	10Hz		10ms		
Operational signal range (signal + common mode)	Voltage mode – AIx: -1V ÷ 10.5V ; CM1: -1V ÷ 0.5V Current mode – AIx: -1V ÷ 5.5V ; CM1: -1V ÷ 0.5V (x=0 or 1)				
Cable	Shielded twisted pair				
Diagnostics ⁽⁸⁾	Analog input overflow				

Relay Outputs (USC-xx-R38)	
Number of outputs	12 (O0 to O11)
Output type	Relay, SPST-NO (Form A)
Isolation groups	Two groups of 6 outputs each
Isolation voltage	
Group to bus	1,500VAC for 1 minute
Group to group	1,500VAC for 1 minute
Output to output within group	None
Current	2A maximum per output (Resistive load) 8A maximum per group
Voltage	250VAC / 30VDC maximum
Minimum load	1mA, 5VDC
Switching time	10ms maximum
Short-circuit protection	None
Life expectancy ⁽¹⁰⁾	100k operations at maximum load

Transistor Outputs (USC-xx-T42)	
Number of outputs	16
Output type	Transistor, Source (pnp)
Isolation voltage	
Output to bus	500VAC for 1 minute
Output to output	None
Outputs power supply to bus	500VAC for 1 minute
Outputs power supply to output	None
Current	0.5A maximum per output Total cumulative output current cannot exceed 6A
Voltage	See Transistor Outputs Power Supply specification below
ON state voltage drop	0.5V maximum
OFF state leakage current	10 μ A maximum
Switching times	Turn-on/off: 80 μ s maximum, Turn-off: 155 μ s maximum (Load resistance < 4k Ω)
PWM Frequency ⁽¹¹⁾	O0, O1: 3kHz max. (Load resistance < 4k Ω)
Short-circuit protection	Yes

Transistor Outputs Power Supply (USC-xx-T42)

Nominal operating voltage	24VDC
Operating voltage	20.4 – 28.8VDC
Maximum current consumption	30mA@24VDC Current consumption does not include load current

LED Indications

I/O LEDs	Color	Indication		
Digital Input	Green	Input state		
Analog Input	Red	On: Input value is in Overflow		
Relay and Transistor Output	Green	Output state		
Status LEDs	Color & State		Indication	
RUN	Green	On	Run mode	
		Blink	This indication is in conjunction with the USB LED. See table below, USB Actions Indications, for details	
	Orange	On	Start-up mode	
		Blink	Stop mode	
ERROR	Red	On/Blink	The Error LED can give indications in conjunction with the RUN and/or USB LED. See the next tables Error Indications and USB Actions Indications for details	
USB	Green	On	A USB drive is detected that contains valid action file(s). See table below, USB Actions Indications, for details	
		Blink	USB Action in progress	
BATT. LOW	Red	On	Battery is low or missing	
FORCE	Red	On	I/O Force on	
Error Indications	LED, Color & State			
	RUN	ERROR	USB	Indication
		Red blink	Off	USB Action has failed – disconnect the USB drive to dismiss the error
		Red blink		HW Configuration Mismatch – the HWC in the UniLogic application does not match the Uni-I/O modules physically connected to the PLC
	Orange blink	Red blink		Application Invalid or Version Mismatch (UniLogic version is not supported by device firmware)
		Red On		Uni-I/O Error (check wiring connections)
	Orange blink	Red On		OS/Application error

USB Actions Indications	LED, Color & State			Indication
	RUN	ERROR	USB	
			Green On	USB drive detected with valid Action file(s) - press CONFIRM ⁽¹²⁾ to start Action or USB Action finished successfully.
			Green blink	USB Action in progress.
	Green blink		Green On	USB Action requires reset; press CONFIRM to restart system
		Red blink	Green Off	USB drive detected, but contains corrupt Action file(s)
		Red blink	Green ON	USB Action ran with error – disconnect the USB drive to dismiss the error.

Environmental	
Protection	IP20, NEMA1
Operating temperature	-20°C to 55°C (-4°F to 131°F)
Storage temperature	-30°C to 70°C (-22°F to 158°F)
Relative Humidity (RH)	5% to 95% (non-condensing)
Operating Altitude	2,000 m (6,562 ft)
Shock	IEC 60068-2-27, 15G, 11ms duration
Vibration	IEC 60068-2-6, 5Hz to 8.4Hz, 3.5mm constant amplitude, 8.4Hz to 150Hz, 1G acceleration

Dimensions	Weight	Size
USC-xx-R38	0.39 Kg (0.86 lb)	As shown in the images below
USC-xx-T42	0.36 Kg (0.79 lb)	

Mechanical Dimensions

Front View

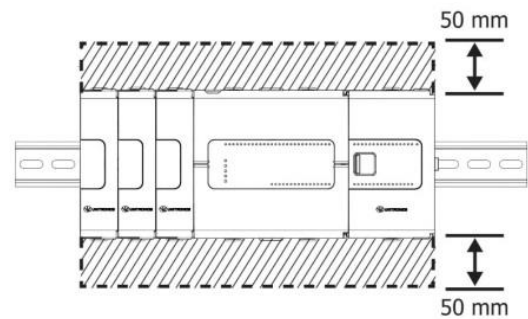
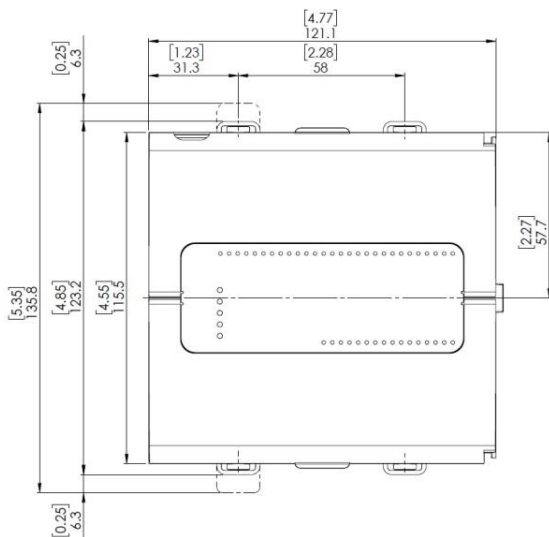

Bottom View

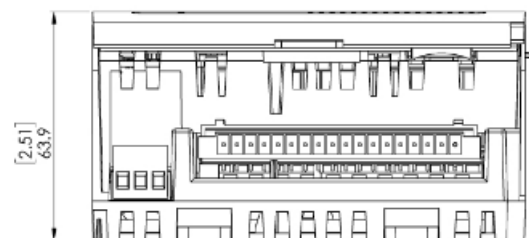

Notes:

1. Eight of the digital inputs (I10-I17) may be configured to function either as normal, or as high speed digital inputs, that can receive high speed pulse signals from up to two sensors or shaft encoders.
2. The Local Expansion Kits comprise a Base unit, an End unit, and a connecting cable. You must plug the Base Unit into the last Uni-I/O™ module plugged into the controller. If no module is present, plug the Base unit into the I/O Bus connector.
3. Uni-COM™ CB modules plug directly into the Uni-COM Jack on the side of the controller. Uni-COM modules may be installed in the following configurations:
 - If a module comprising a serial port is plugged directly into the controller, it may be followed only by another serial module, for a total of 2.
 - If your configuration includes a CANbus module, it must be plugged directly into the controller. The CANbus module may be followed by up to two serial modules, for a total of 3.
 For more information, refer to the product's installation guide.
4. When replacing the unit's battery, make sure that the new one has environmental specifications that are similar or better than the one specified in this document.
5. The USB device port is used to connect the device to a PC.
6. The 4-20mA input option is implemented using 0-20mA input range.
7. The analog inputs measure values that are slightly higher than the nominal input range (Input Over-range).

Note that when the input overflow occurs, it is indicated in the corresponding I/O Status tag as well as by the respective input LED (see LED Indications), while the input value is registered as the maximum permissible value. For example, if the specified input range is 0 ÷ 10V, the Over-range values can reach up to 10.15V, and any input voltage higher than that will still register as 10.15V while the Overflow system tag is turned on.
8. See LED Indications Table for description of the relevant indications. Note that the diagnostics results are also indicated in the system tags and can be observed through the UniApps™ or the online state of the UniLogic®.
9. Step response and update time are independent of the number of channels that are used.
10. Life expectancy of the relay contacts depends on the application that they are used in. The product's installation guide provides procedures for using the contacts with long cables or with inductive loads.
11. Outputs O0 and O1 can be configured as either normal digital outputs or as PWM outputs. PWM outputs specifications apply only when outputs are configured as PWM outputs.
12. This refers to the CONFIRM button on the controller USB Actions; press it if the indication requires.

The information in this document reflects products at the date of printing. Unitronics reserves the right, subject to all applicable laws, at any time, at its sole discretion, and without notice, to discontinue or change the features, designs, materials and other specifications of its products, and to either permanently or temporarily withdraw any of the forgoing from the market.

All information in this document is provided "as is" without warranty of any kind, either expressed or implied, including but not limited to any implied warranties of merchantability, fitness for a particular purpose, or non-infringement. Unitronics assumes no responsibility for errors or omissions in the information presented in this document. In no event shall Unitronics be liable for any special, incidental, indirect or consequential damages of any kind, or any damages whatsoever arising out of or in connection with the use or performance of this information.

The tradenames, trademarks, logos and service marks presented in this document, including their design, are the property of Unitronics (1989) (R"G) Ltd. or other third parties and you are not permitted to use them without the prior written consent of Unitronics or such third party as may own them.