

# LS-551-0700-LIU22PN8X-H1151

## Level Sensor – With Analog Output and 2 × Switching Outputs

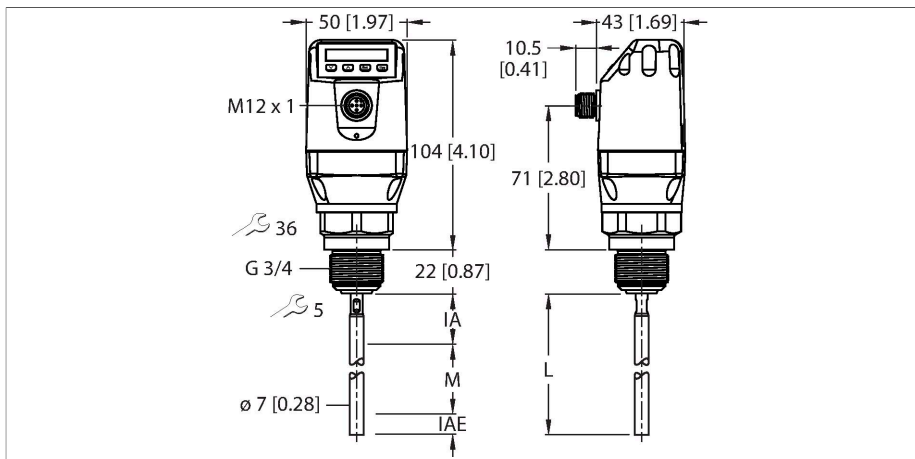

### Technical data

Type	LS-551-0700-LIU22PN8X-H1151
ID	100001868
Medium temperature	-20...+100 °C
Application area	liquids
Probe length (L)	700 mm
Max. loading of probe	6 Nm
Probe accuracy	± 5 mm
Temperature drift	≤ 0.1
Hysteresis	≥ 2 mm
Reproducibility	≤ 2 mm
Inactive area on process connection (IA)	25 mm
Inactive area at end of probe (IAE)	10 mm
Dielectric constant	≥ 5; ≥ 1.8 mit Koaxialrohr (Zubehör)
Pressure resistance	-1...10 bar
<b>Electrical data</b>	
Operating voltage	12...30 VDC
Current consumption	≤ 100 mA
Short-circuit/reverse polarity protection	yes / yes
Inductive load	< 1 H
Capacitive load	100 nF
Insulation class	III
<b>Outputs</b>	
Output 1	Analog output (current/voltage, automatic switching depending on load)
Output 2	IO-Link/switching output (PNP)
Output 3	Switching output (PNP/NPN)

### Features

- Level detection and continuous level measurement
- Easy to service and quick to deploy without calibration
- Very flexible since probes can be shortened
- Easy installation thanks to compact, rotatable housing with display
- Process temperature up to 100 °C
- Process pressure up to 10 bar
- Small blind zones, ideal for small containers
- Coaxial tube available for non-metallic tanks
- IO-Link 1.1
- 12...30 VDC
- 1 × analog output 4... 20 mA/0... 10 V (automatic switchover depending on load)
- 2 × PNP/IO-Link or PNP/NPN transistor outputs, each switchable
- Dielectric constant: ≥ 5 for mono-rod probe/rope probe or ≥ 1.8 with coaxial tube
- Process connection G3/4" male thread
- Probe length 700 mm

### Wiring diagram

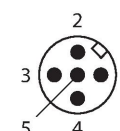
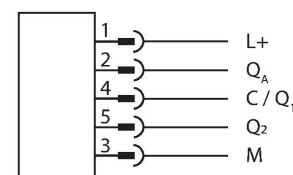

## Technical data

<b>Switching output</b>	
Communication protocol	IO-Link
Output function	NO/NC, PNP/NPN, analog output
<b>Analog output</b>	
Current output	4...20 mA
High level signal current	20...20.5 mA
Low level signal current	3.8...4 mA
Load resistance current output	≤ 0.5 kΩ
Voltage output	0...10 V
High level signal voltage	U <sub>v</sub> - 2 V
Low-level signal voltage	≤ 2 V
Load resistance voltage output	≥ 0.75 kΩ
Response time typical	< 400 ms
<b>IO-Link</b>	
IO-Link specification	V 1.1
IO-Link port type	Class A
Transmission physics	COM 2 (38.4 kBaud)
Frame type	2.2
Included in the SIDI GSDML	Yes
<b>Mechanical data</b>	
Housing material	Plastic, PBT
Materials (contact with media)	Stainless steel 1.4404 (AISI 316L), PTFE, FKM
Process connection	G 3/4" male thread
Sealing material	Aramid fibers, bound with NBR
Electrical connection	Connector, M12 × 1
Protection class	IP67
<b>Environmental conditions</b>	
Ambient temperature	-20...+60 °C
Storage temperature	-40...+80 °C
<b>Tests/approvals</b>	
UL registration number	E356899
<b>Displays/Operating elements</b>	
Display	Digital display
MTTF	194 years

## Functional principle

The level sensors of the LS-5 series work according to the principle of the guided microwave. The so-called Time Domain Reflectometry (TDR) is used. This method emits an electromagnetic wave along the probe. When the wave reaches the medium, it is partially reflected due to the dielectric constant compared to air. The electromagnetic wave is picked up again by the sensor and the distance to the liquid can now be determined via the transit time.

## Accessories

LSCT-51-0700

10001882

Coaxial tube for LS-5 level sensors (only G3/4") for use in non-metallic containers, tube length 700 mm, process connection G3/4"

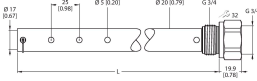

HW1342

LSCT-34-0700

10001883

Coaxial tube for LS-5 level sensors (only G3/4") for use in non-metallic containers, tube length 700 mm, process connection 3/4" NPT



HW1342

LSRP-1000

10002197

Rod probe for screwing into LS-5 level sensors, length 1000 mm

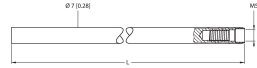

HW1342

LSCT-51-1000

100015813

Coaxial tube for LS-5 level sensors (only G3/4") for use in non-metallic containers, tube length 1000 mm, process connection G3/4"



HW1342

LSCT-51-1500

100015814

Coaxial tube for LS-5 level sensors (only G3/4") for use in non-metallic containers, tube length 1500 mm, process connection G3/4"

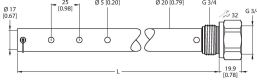

HW1342

LSCT-51-2000

100015815

Coaxial tube for LS-5 level sensors (only G3/4") for use in non-metallic containers, tube length 2000 mm, process connection G3/4"

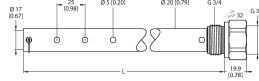

HW1342

LSCT-34-1000

100015818

Coaxial tube for LS-5 level sensors (only G3/4") for use in non-metallic containers, tube length 1000 mm, process connection 3/4" NPT

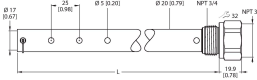

HW1342

LSCT-34-1500

100015817

Coaxial tube for LS-5 level sensors (only G3/4") for use in non-metallic containers, tube length 1500 mm, process connection 3/4" NPT

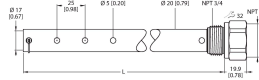

HW1342

LSCT-34-2000

100015816

Coaxial tube for LS-5 level sensors (only G3/4") for use in non-metallic containers, tube length 2000 mm, process connection 3/4" NPT

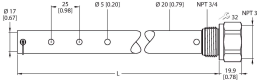

HW1342