



EN Operating instructions. pages 1 bis 9
Original

Content

1 About this document

1.1 Function 1

1.2 Target group: authorised qualified personnel. 1

1.3 Explanation of the symbols used 1

1.4 Appropriate use 1

1.5 General safety instructions 1

1.6 Warning about misuse 2

1.7 Exclusion of liability 2

2 Product description

2.1 Ordering code 2

2.2 Special versions. 2

2.3 Purpose 2

2.4 Technical data 3

2.5 Safety classification of the interlocking function. 4

2.6 Safety classification of the interlock function 4

3 Assembly

3.1 General mounting instructions 4

3.2 Dimensions 5

3.3 Mounting of individually coded actuators. 6

3.4 Accessories 7

4 Electrical connection

4.1 General information for electrical connection. 7

4.2 Wiring examples 7

4.3 Contact Options 8

5 Set-up and maintenance

5.1 Functional testing. 8

5.2 Maintenance 8

6 Disassembly and disposal

6.1 Disassembly. 8

6.2 Disposal 8

7 Declaration of conformity

1. About this document

1.1 Function
This operating instructions manual provides all the information you need for the mounting, set-up and commissioning to ensure the safe operation and disassembly of the safety switchgear. The operating instructions must be available in a legible condition and a complete version in the vicinity of the device.

1.2 Target group: authorised qualified personnel
All operations described in this operating instructions manual must be carried out by trained specialist personnel, authorised by the plant operator only.

Please make sure that you have read and understood these operating instructions and that you know all applicable legislations regarding occupational safety and accident prevention prior to installation and putting the component into operation.

The machine builder must carefully select the harmonised standards to be complied with as well as other technical specifications for the selection, mounting and integration of the components.

1.3 Explanation of the symbols used

 **Information, hint, note:**
This symbol indicates useful additional information.

 **Caution:** Failure to comply with this warning notice could lead to failures or malfunctions.
Warning: Failure to comply with this warning notice could lead to physical injury and/or damage to the machine.

1.4 Appropriate use
The Schmersal range of products is not intended for private consumers.

The products described in these operating instructions are developed to execute safety-related functions as part of an entire plant or machine. It is the responsibility of the manufacturer of a machine or plant to ensure the correct functionality of the entire machine or plant.

The safety switchgear must be exclusively used in accordance with the versions listed below or for the applications authorised by the manufacturer. Detailed information regarding the range of applications can be found in the chapter "Product description".

1.5 General safety instructions
The user must observe the safety instructions in this operating instructions manual, the country specific installation standards as well as all prevailing safety regulations and accident prevention rules.

 Further technical information can be found in the Schmersal catalogues or in the online catalogue on the Internet: products.schmersal.com.

The information contained in this operating instructions manual is provided without liability and is subject to technical modifications.

There are no residual risks, provided that the safety instructions as well as the instructions regarding mounting, commissioning, operation and maintenance are observed.

1.6 Warning about misuse



In case of improper use or manipulation of the safety switchgear, personal hazards or damages to machinery or plant components cannot be excluded.

1.7 Exclusion of liability

We shall accept no liability for damages and malfunctions resulting from defective mounting or failure to comply with this operating instructions manual. The manufacturer shall accept no liability for damages resulting from the use of unauthorised spare parts or accessories.

For safety reasons, invasive work on the device as well as arbitrary repairs, conversions and modifications to the device are strictly forbidden, the manufacturer shall accept no liability for damages resulting from such invasive work, arbitrary repairs, conversions and/or modifications to the device.

2. Product description

2.1 Ordering code

This operating instructions manual applies to the following types:

AZM150SK-①R②③④⑤-⑥

No.	Option	Description		
①		Magnet: Actuator:		
		02 / 11 2 NC 1 NO / 1 NC		
		11 / 11 1 NO / 1 NC 1 NO / 1 NC		
		11 / 02 1 NO / 1 NC 2 NC		
		02 / 02 2 NC 2 NC		
		01 / 03 1 NC 3 NC		
		03 / 01 3 NC 1 NC		
		01 / 12 1 NC 1 NO / 2 NC		
		②	I	Standard coded (Actuator not included in delivery)
				Individually coded (incl. actuator see ⑥)
③	A	Power to unlock		
		Power to lock		
④		Manual release		
		Emergency Exit		
		Emergency release		
⑤		U _s 24 VDC		
		U _s 110 VAC		
		U _s 230 VAC		
⑥		Including actuator for individually coded versions I:		
		B1 Straight actuator B1		
		B5 Angled actuator B5		
		B6L Flexible actuator B6, left		
		B6R Flexible actuator B6, right		

Standard coded actuator (not included in delivery)

AZM150-B1	Straight actuator
AZM150-B5	Angled actuator
AZM150-B6	Flexible actuator

AZM150①-②-③R④⑤⑥-024-⑦ with connector plug M12, 8-pole (only 24 VDC)

No.	Option	Description
①	Z	Guard locking monitored (Variants 02/..., not in power to lock version)
	B	Actuator monitoring (Variants ../02)
②	ST	Connector plug M12 bottom
	STR	Connector plug M12 right
	STL	Connector plug M12 left
③		Magnet: Actuator:
		10 / 02 1 NO 2 NC
		02 / 10 2 NC 1 NO
		01 / 02 1 NC 2 NC
		02 / 01 2 NC 1 NC
④	I	Standard coded (Actuator not included in delivery)
		Individually coded (incl. actuator see ⑦)
⑤	A	Power to unlock
		Power to lock
⑥	T	Manual release
		Emergency Exit
⑦	N	Emergency release
		Including actuator for individually coded versions I:
		B1 Straight actuator B1
		B5 Angled actuator B5
		B6L Flexible actuator B6, left
		B6R Flexible actuator B6, right

Standard coded actuator (not included in delivery)

AZM150-B1	Straight actuator
AZM150-B5	Angled actuator
AZM150-B6	Flexible actuator



Only if the information described in this operating instructions manual are realised correctly, the safety function and therefore the compliance with the Machinery Directive is maintained.

2.2 Special versions

For special versions, which are not listed in the ordering code below 2.1, these specifications apply accordingly, provided that they correspond to the standard version.

2.3 Purpose

The solenoid interlock has been designed to prevent in conjunction with the control part of a machine, movable safety guards from being opened before hazardous conditions have been eliminated. The solenoid interlocks with individual coding offer a higher protection against tampering and remain off when the guard system is unlocked or open.



Interlocks with power to lock principle may only be used in special cases after a thorough evaluation of the accident risk, since the safety guard can be opened immediately on failure of the power supply or upon activation of the main switch.



The safety switchgears are classified according to EN ISO 14119 as type 2 interlocking devices. Designs with individual coding are classified as highly coded.



The AZM150ST is also for use in combination with the safety field box SFB made by Schmersal.

Manual release

(for set-up, maintenance, etc.)

The rear and cover-side manual release can be actuated independently of one another. Check that both are in the starting position when putting the device into operation.

The manual release is realised by turning the triangular key, so that the locking bolt is pulled into the unlocking position. The normal locking function is only restored after the triangular key has been returned to its original position. After being put into operation, the manual release must be secured by installing the seals, which are included in delivery.

Manual release

Locked

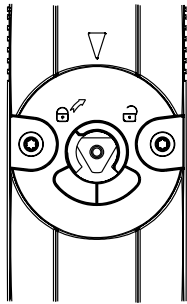

Unlocked

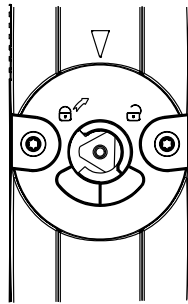

Triangular key TK-M5 (101100887) available as accessory.

Emergency release (ordering suffix -N)

(Fitting only from outside the hazardous area)



The emergency release should only be used in an emergency. The solenoid interlock should be installed and/or protected so that an inadvertent opening of the interlock by an emergency release can be prevented. The emergency release must be clearly labelled that it should only be used in an emergency. The label can be used that was included in the delivery.

To activate the emergency release, turn the red lever 90° in the direction of the arrow as far as it will go. In this position, the safety guard can be opened. The lever is latched and cannot be returned to its original position. To cancel the blocking condition, the central mounting screw must be loosened to such extent that the lever can be turned back into its original position. The screw must then be re-tightened.

Emergency exit (Ordering suffix -T)

(Fitting and actuation only from within the hazardous area)

To activate the emergency exit of version T, turn the red lever 90° in the direction of the arrow as far as it will go. In this position, the safety guard can be opened. The blocked position is cancelled by turning the lever in the opposite direction. In unlocked position, the safety guard is protected against unintentional closing.

Emergency release / Emergency exit

Locked

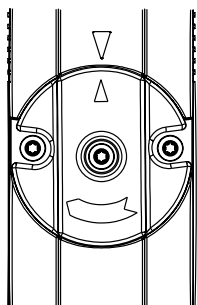

Unlocked

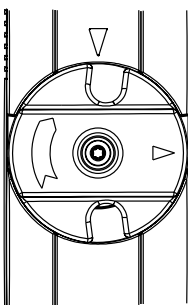

The user must evaluate and design the safety chain in accordance with the relevant standards and the required safety level.



The entire concept of the control system, in which the safety component is integrated, must be validated to the relevant standards.

2.4 Technical data

Standards:	EN 60947-5-1, EN ISO 14119
Enclosure:	glass-fibre reinforced thermoplastic, self-extinguishing
Actuator and locking bolt:	stainless steel 1.4301
Contact material:	Silver
Coding level according to EN ISO 14119:	
- Standard coding version:	low
- Individual coding version:	high
Degree of protection:	IP65, IP67
Insulation protection class:	II, III
- version with connector plug M12:	III
Overvoltage category:	II
Degree of pollution:	2
Contact type:	Change-over contact with double break type Zb, with galvanically separated contact bridges
Switching system:	⊖ acc. EN 60947-5-1 slow action, NC contact with positive break
Positive break travel (unlocked):	5 mm
Positive break force (unlocked):	10 N for each NC contact fitted
Termination:	screw terminals or connector plug M12, 8-pole
Cable entry:	3x M20
Cable type:	flexible
Max. cable section:	0.25 mm ² ... 1.5 mm ² (incl. conductor ferrules without plastic collar)
Holding force F_{max} :	1,950 N
Holding force F_{zh} :	1,500 N
Latching force:	50 N
Actuating speed:	≤ 0.3 m/s
Actuating frequency:	max. 1,000 operations/h
Mechanical life:	1,000,000 switching operations
- Note:	from device version V2 (see type plate)
Ambient temperature:	-25 °C ... +55 °C
Storage temperature:	-40 °C ... +85 °C
Relative humidity:	max. 93 %, non condensing, non icing
Electrical data:	
Utilisation category:	AC-15, DC-13
Rated operating current I_e / voltage U_e :	
- version with screw terminals:	4 A / 230 VAC, 4 A / 24 VDC
- version with connector plug M12:	2 A / 24 VDC
Rated impulse withstand voltage U_{imp} :	
- version with screw terminals:	4 kV
- version with connector plug M12:	0.8 kV
Rated insulation voltage U_i :	
- version with screw terminals:	300 V
- version with connector plug M12:	30 V
Thermal test current I_{the} :	
- version with screw terminals:	5 A
- version with connector plug M12:	2 A
Max. fuse rating:	6 A gG
Rated rated short-circuit current:	1,000 A
Rated control voltage U_s :	24 VDC, 110 VAC, 230 VAC
Electrical data – Magnet control:	
Duty ratio solenoid:	100%
Power consumption:	≤ 8.5 W
Accepted test pulse duration on input signal:	≤ 5.0 ms
- With test pulse interval of:	≥ 50 ms

2.5 Safety classification of the interlocking function

Standards:	EN ISO 13849-1
Envisaged structure:	
- Basically:	applicable up to Cat. 1 / PL c
- With 2-channel usage and fault exclusion mechanism*:	applicable up to Cat. 3 / PL d with suitable logic unit
B _{10D} NC contact:	
- Mechanical life:	2,000,000
- Electrical life:	on request
B _{10D} NO contact at 10% ohmic contact load:	1,000,000
Mission time:	20 years

* If a fault exclusion to the 1-channel mechanics is authorised.

$$MTTF_D = \frac{B_{10D}}{0,1 \times n_{op}} \quad n_{op} = \frac{d_{op} \times h_{op} \times 3600 \text{ s/h}}{t_{cycle}}$$

(Determined values can vary depending on the application-specific parameters h_{op} , d_{op} and t_{cycle} as well as the load.)

If multiple safety components are wired in series, the Performance Level to EN ISO 13849-1 will be reduced due to the restricted error detection under certain circumstances.

2.6 Safety classification of the interlock function

If the device is used as an interlock for personal safety, a safety classification of the guard locking function is required.

When classifying the interlock function, a distinction must be made between monitoring of the interlock function (locking function) and controlling the unlocking function.

The following safety classification of the unlocking function is based on the application of the principle of safety energy disconnection for the solenoid supply.



The classification of the unlocking function is only valid for devices with monitored guard locking function and in the power to unlock version (see ordering code).

A fault exclusion for the guard locking function can be assumed by an external safety energy disconnection.

In this case, the guard locking function does not have an effect on the failure probability of the unlock function.

The safety level of the unlock function is determined exclusively by the external safety power shutdown.

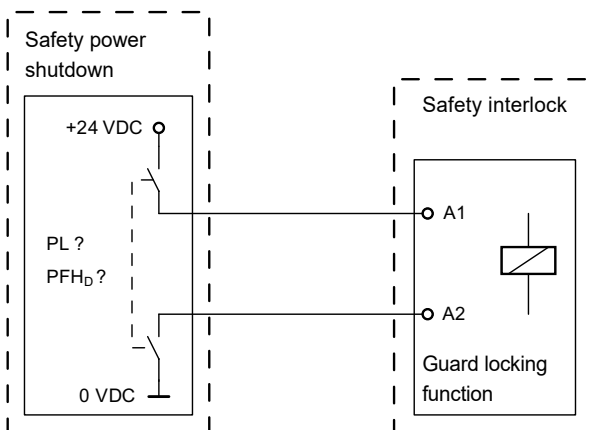

In the safety classification of the unlock function, a fault exclusion can be applied for the interlock.



Fault exclusion with regard to wiring routing must be observed.



If for a certain application the power to unlock version of a solenoid interlock cannot be used, for this exception an interlock with power to lock can be used if additional safety measure need to be realised that have an equivalent safety level.

Safety classification of the interlock function on connection to the safety fieldbox SFB

The safety field box SFB activates the unlocking function of the guard lock with a secure and monitored output.

In the event of a fault resulting in the unlocking of the guard locking function, it will be reliably detected by the SFB.

To simplify the safety classification of the guard locking function, the following parameters can be assumed for connection of the solenoid interlock to the SFB.:

Standards:	EN ISO 13849-1
PL:	d
Control Category:	2
PFH:	$\leq 3.01 \times 10^{-7} / h$
Mission time:	20 years



The safety classification of the guard locking function refers to the component solenoid interlock as part of the complete system. In the event of a fault resulting in the unlocking of the guard locking function, it will be reliably detected by the SFB. If a fault is detected, the SFB passivates the slot used and switches the safety function of the solenoid interlock in the safety controller off. When such a fault occurs, the protective equipment may open immediately, just once, before the safe condition of the machine is reached. The system reaction of category 2 allows that a fault can occur between tests causing the loss of the safety function which is detected by the test.

3. Assembly

3.1 General mounting instructions



Please observe the remarks of the standards EN ISO 12100, EN ISO 14119 and EN ISO 14120.

4 M5 holes are provided for mounting the enclosure. Screws with strength class 8.8 and a tightening torque of 1.3 to 1.5 Nm with plain washers (not included in delivery) must be used for mounting. The solenoid interlock is double insulated. The use of an earth wire is not authorised. The solenoid interlock must not be used as an end stop. Any mounting position. The mounting position must be chosen so as to avoid the penetration of dirt in the used holes. Unused actuator openings must be sealed with slot sealing plugs.



Detailed information on actuators with standard coding (not included in delivery) AZM150-B1, AZM150-B5 and AZM150-B6 and their mounting can be found in the actuator operating instructions.

The insertion funnel on the head of the interlock allows insertion of a flexible actuator with an axial offset of $\leq \pm 1$ and a height offset of $\leq \pm 1$.



The solenoid interlock and actuator must be mounted such that on unlocking, no tensile forces are exerted in the direction of actuation.

The actuator must be inserted into the actuator head easily. For doors that do not ensure this is possible, a door catch must be installed to prevent damage to the device.



When used in ambient temperatures > 40°C, the solenoid interlock must be protected against contact with inflammable materials or inadvertent personal contact.

Choosing the actuating planes

Offsetting the actuating head enables actuation of 8 levels.

1. Cover screws (Torx 10) must be loosened
2. Remove cover
3. Turn actuating head to desired position
4. Fit the cover and engage, tighten the cover screws (torque 0.5 Nm)

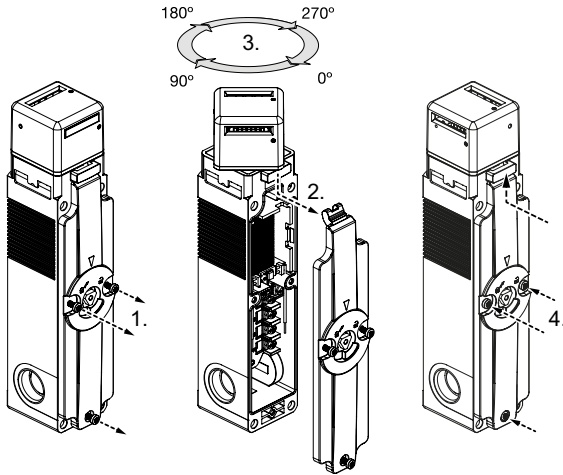

Do not lever out the side tabs. Levering out the tabs will damage the device.

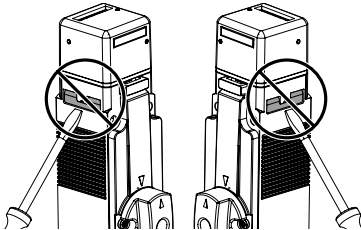

3.2 Dimensions

All measurements in mm.

AZM150

with cover-side manual release

and rear manual release

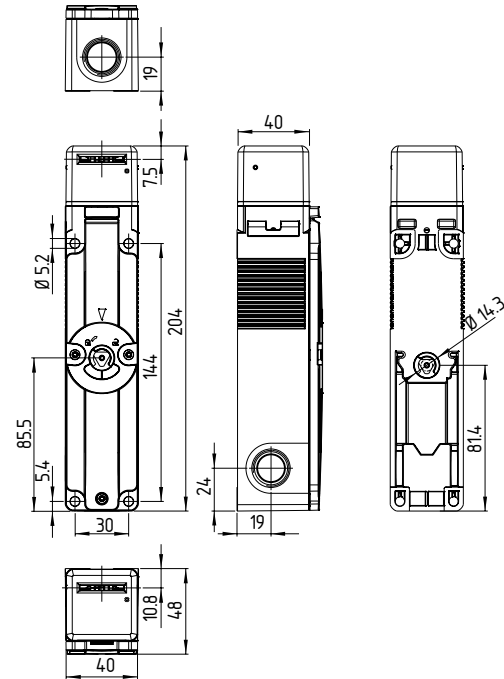

AZM150

with cover-side emergency lever -N or -T

with Connector plug M 12

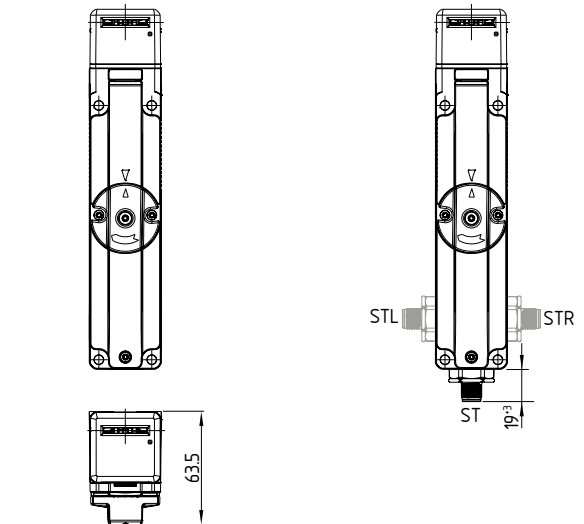

The side connector is oriented such that when an angled connector is assembled, the cables always exit downwards (in the case of the lower connector and assembly of angled connector plugs, the outgoing cable runs to the right).

3.3 Mounting of individually coded actuators



The marks on the used actuator opening of the solenoid interlock and on the actuator must be opposite.

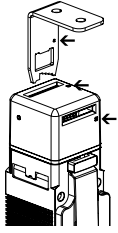

In the as-delivery condition, the actuator of the individually coded safety switch AZM150 ... I is inserted in the upper actuator inlet.

On delivery, the actuator is in inserted condition. For power-to-unlock components, the actuator must be released by means of the manual release. If the triangular key is turned 90°, the locking bolt is pulled into the unlocking position. The normal locking function is only restored after the triangular key has been returned to its original position.



The actuator must be permanently fitted to the safety guards and protected against displacement by suitable measures (tamperproof screws, gluing, drilling, pinning).

Please observe that, when fixing the switch e.g. by means of riveting or welding, the insertion depth of the actuator is not modified. There are different actuator types available:

The actuators AZM150-B1 and AZM150-B5 are suitable for sliding and removable safety guards. For hinged guards, the AZM150-B6L or AZM150-B6R actuator.

When the switch is fitted on a hinged safety guard, please ensure that the point of rotation is located within the range of the upper surface of the safety switch, in which the actuator hook is inserted (refer to table).

Actuating radii				
	R_{min} [mm]	d [mm]	R_{min} [mm]	d [mm]
AZM150-B6L	250	18.5	250	23
AZM150-B6R	250	18.5	250	23



Key

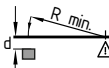

Actuator radii, when the actuator is pivoted in from the front

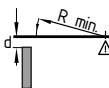

Actuator radii, when the actuator is pivoted in from above

The axis of the hinge must be d mm above and in a parallel plane to the top surface of the safety switch. The basis setting provides a minimum radius of R_{min} .

Setting screw

The AZM150-B6L or AZM150-B6R actuator is set to the smallest radius in factory. To increase the radius, the setting screws a + b must be turned by means of a hexagonal key A/F 2 mm.

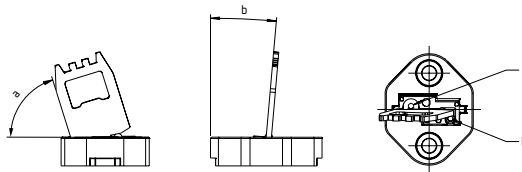

Strength of the actuator screws 5.6.

Actuator AZM150-B1

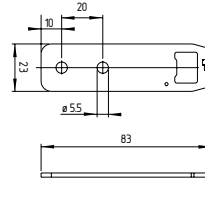

Installation position with actuator inserted
(all measurements ± 0.3 mm)

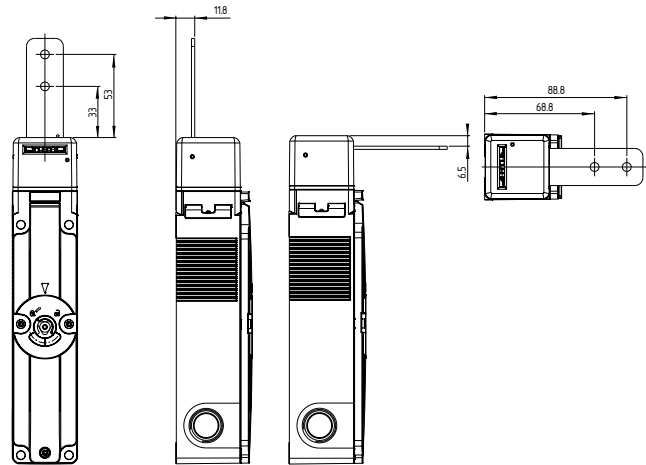

Actuator AZM150-B5

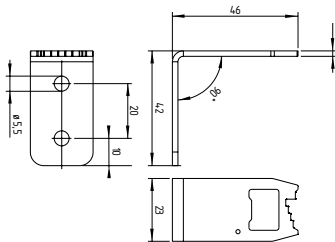

Installation position with actuator inserted
(all measurements ± 0.3 mm)

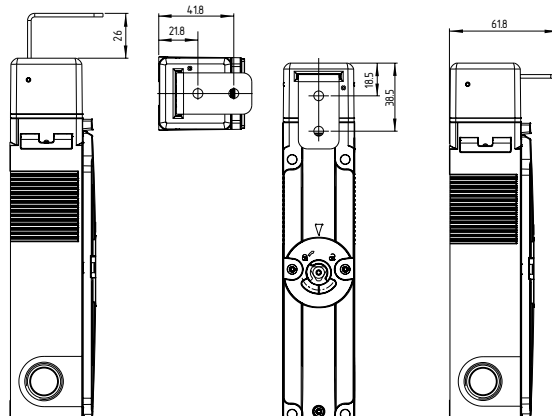

Actuator AZM150-B6L

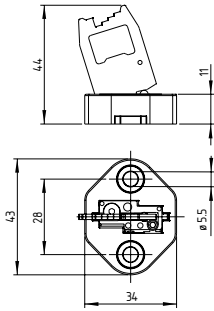

Actuator AZM150-B6R

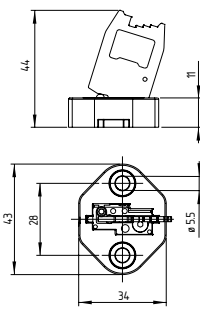

Installation position with actuator inserted
(all measurements ± 0.3 mm)

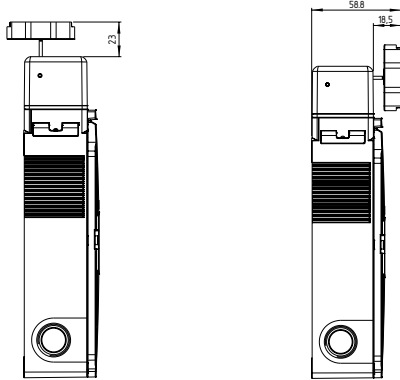

3.4 Accessories

Description	Designation	Ordering code
Mounting plate	MP-AZM150-1	153046398
Mounting plate, angled	MP-AZM150-2-R/L	153046399
Triangular key	TK-M5	101100887
Door handle system	DHS-150-BKBU-L	137000626
	DHS-150-BKBU-R	137000625
Lockout tag	SZ150-1	153027887
Cable gland	M20 x 1,5	on request
Tamperproof screws M5 x 14, 2 pieces	ACC-NRS-M5X14-FHS-2PCS	103033698

Connecting cables with coupling (female) IP67, M12, 8-pole – 8 x 0.25 mm²

Cable length	Ordering code
2.5 m	103011415
5.0 m	103007358
10.0 m	103007359
15.0 m	103011414

Connecting cables with angled coupling (female) IP67, M12, 8-pole – 8 x 0.25 mm²

Cable length	Ordering code
2.5 m	103043110
5.0 m	103043119
10.0 m	103043120

Connecting cables to connect to the safety fieldbox IP67, M12, 8-pole – 8 x 0.25 mm²

Cable length	Ordering code
1.0 m	101217787
1.5 m	101217788
2.5 m	101217789
5.0 m	101217790

4. Electrical connection

4.1 General information for electrical connection



The electrical connection may only be carried out by authorised personnel in a de-energised condition.



To connect the AZM150 as a connector variant, a PELV mains supply device must be used in accordance with EN 60204-1.



If the risk analysis indicates the use of a monitored interlock, only contacts marked with the symbol may be integrated into safety circuit.

Appropriate cable glands with a suitable degree of protection are to be used. Remove the walls of the mounting holes by inserting the cable entry. All plastic residues must be removed from the switch compartment.

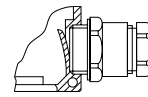

After wiring, the wiring compartment must be cleaned (i.e. remove excess cables etc.).

Max. cable section: 0.25 ... 1.5 mm²
(incl. conductor ferrules without plastic collar)

Removing the cable sheathing

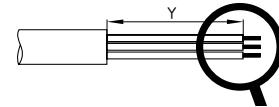

A1	A2	y = 71 mm
1.	1.	y = 67 mm
2.	2.	y = 57 mm
3.	3.	y = 47 mm
4.	4.	y = 37 mm

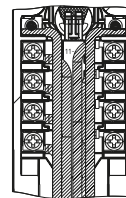

Settle length x of the conductor: 6 mm

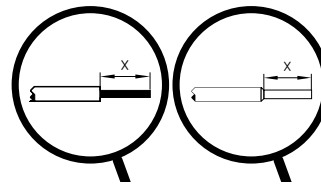

4.2 Wiring examples

When routing the cables, account for an offset of the terminals at the left and right terminal screws.

Route the cables neatly next to or above the other cables.

A1	A2	A1	A2	A1	A2
1.	1.	1.	1.	1.	1.
2.	2.	2.	2.	2.	2.
3.	3.	3.	3.	3.	3.
4.	4.	4.	4.	4.	4.



The wiring must be configured such that moving parts are not blocked.

4.3 Contact Options

Contacts shown in a de-energised condition and with the actuator inserted.

Power to unlock

Guard system closed and interlocked

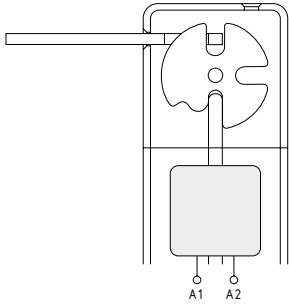

Power to lock

Guard system closed and not interlocked

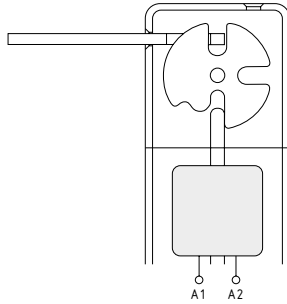

AZM150SK...-02/11

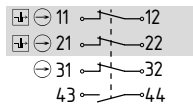

AZM150SK...-02/11...A

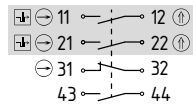

AZM150SK...-11/11

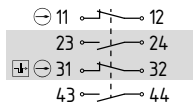

AZM150SK...-11/11...A

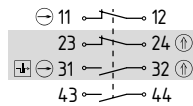

AZM150SK...-11/02

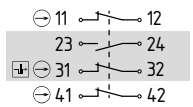

AZM150SK...-11/02...A

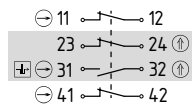

AZM150SK...-02/02

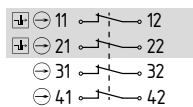

AZM150SK...-02/02...A

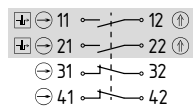

AZM150SK...-01/03

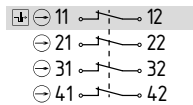

AZM150SK...-01/03...A

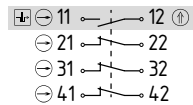

AZM150SK...-03/01

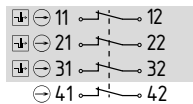

AZM150SK...-03/01...A

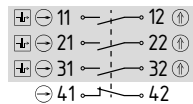

AZM150SK...-01/12

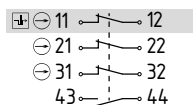

AZM150SK...-01/12...A

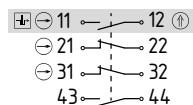

Key

- Magnet contacts
- Positive break NC contact
- Monitoring the interlock according to EN ISO 14119
- Actuated

AZM150 with connector plug M12, 8-pole



The AZM150ST is also for use in combination with the safety field box SFB made by Schmersal.

Power to unlock

AZM150B-ST.-01/02

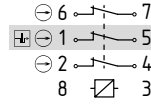

Power to lock

AZM150B-ST.-01/02...A

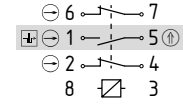

AZM150B-ST.-10/02

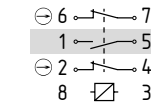

AZM150B-ST.-10/02...A

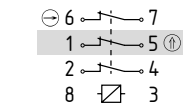

AZM150Z-ST.-02/01

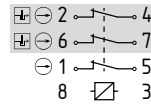

AZM150Z-ST.-02/10

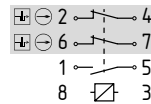

5. Set-up and maintenance

5.1 Functional testing

The safety function of the safety components must be tested. The following conditions must be previously checked and met:

1. Fitting of the solenoid interlock and the actuator
2. Check the integrity of the cable entry and connections
3. Check the switch enclosure for damage
4. Check that both the cover-side and rear manual releases are in the starting position

5.2 Maintenance

A regular visual inspection and functional test, including the following steps, is recommended:

1. Check for tight installation of the actuator and the switch
2. Remove particles of dust and soiling
3. Check cable entry and connections



Adequate measures must be taken to ensure protection against tampering either to prevent tampering of the safety guard, for instance by means of replacement actuators.

Damaged or defective components must be replaced.

6. Disassembly and disposal

6.1 Disassembly

The safety switchgear must be disassembled in a de-energised condition only.

6.2 Disposal



The safety switchgear must be disposed of in an appropriate manner in accordance with the national prescriptions and legislations.

7. Declaration of conformity

We declare under our sole responsibility that the products mentioned comply with all relevant provisions of the directives and regulations listed below and conform to the following standards.

Relevant Directives:



2006/42/EC
2014/30/EU
2011/65/EU



SI 2008/1597
SI 2016/1091
SI 2012/3032

Applied standards:

EN 60947-5-1:2017 + AC:2020
EN ISO 14119:2013



The currently valid declaration of conformity can be downloaded from the internet at products.schmersal.com.

K.A. Schmersal GmbH & Co. KG
Mödinghofe 30, 42279 Wuppertal
Germany

Phone: +49 202 6474-0
Telefax: +49 202 6474-100
E-Mail: info@schmersal.com
Internet: www.schmersal.com

Production site:

SCHMERSAL
Industrial Switchgear (Shanghai) Co., Ltd.
Cao Ying Road 3336
201712 Shanghai / Qingpu, P.R.CHINA

Phone: +86-21-63 75 82 87
Fax: +86-21-69 21 43 98
E-Mail: info@schmersal.com.cn
Internet: www.schmersal.com.cn

施迈赛工业开关制造（上海）有限公司
地址：上海市青浦区漕盈路3336号
邮编：201712

电话：021-63 75 82 87
传真：021-69 21 43 98
邮箱：info@schmersal.com.cn
网址：www.schmersal.com.cn