



**EN** Operating instructions . . . . .pages 1 to 8  
Original

**Content**

**1 About this document**

1.1 Function . . . . . 1

1.2 Target group: authorised qualified personnel. . . . . 1

1.3 Explanation of the symbols used . . . . . 1

1.4 Appropriate use . . . . . 1

1.5 General safety instructions . . . . . 1

1.6 Warning about misuse . . . . . 2

1.7 Exclusion of liability . . . . . 2

**2 Product description**

2.1 Ordering code . . . . . 2

2.2 Special versions. . . . . 2

2.3 Determination and use for functional safety. . . . . 2

2.4 Determination and use for explosion protection. . . . . 3

2.5 Technical data . . . . . 3

2.6 Safety classification . . . . . 4

2.7 Safety-technical data – Intrinsic safety . . . . . 4

**3 Mounting**

3.1 General mounting instructions . . . . . 4

3.2 Dimensions . . . . . 4

3.3 Pull wire system accessories. . . . . 5

**4 Electrical connection**

4.1 General information for electrical connection. . . . . 6

4.2 Contact Options . . . . . 6

4.3 Accessories for cable entry . . . . . 6

4.4 Connector EX-I-RS655 . . . . . 6

4.5 Connector EX-RS655 . . . . . 7

4.6 Connector EX-RS655-...-DS-2D / EX-RS655-...-DN-2D. . . . . 7

4.7 System components DuplineSafe® . . . . . 7

4.8 System components Dupline® . . . . . 7

**5 Set-up and maintenance**

5.1 Functional testing. . . . . 7

5.2 Maintenance . . . . . 7

**6 Disassembly and disposal**

6.1 Disassembly. . . . . 7

6.2 Disposal . . . . . 7

**7 EU Declaration of conformity**

**1. About this document**

**1.1 Function**

This operating instructions manual provides all the information you need for the mounting, set-up and commissioning to ensure the safe operation and disassembly of the safety switchgear. The operating instructions must be available in a legible condition and a complete version in the vicinity of the device.

**1.2 Target group: authorised qualified personnel**

All operations described in this operating instructions manual must be carried out by trained specialist personnel, authorised by the plant operator only.

Please make sure that you have read and understood these operating instructions and that you know all applicable legislations regarding occupational safety and accident prevention prior to installation and putting the component into operation.

The machine builder must carefully select the harmonised standards to be complied with as well as other technical specifications for the selection, mounting and integration of the components.

**1.3 Explanation of the symbols used**



**Information, hint, note:**

This symbol indicates useful additional information.



**Caution:** Failure to comply with this warning notice could lead to failures or malfunctions.

**Warning:** Failure to comply with this warning notice could lead to physical injury and/or damage to the machine.

**1.4 Appropriate use**

The Schmersal range of products is not intended for private consumers.

The products described in these operating instructions are developed to execute safety-related functions as part of an entire plant or machine. It is the responsibility of the manufacturer of a machine or plant to ensure the correct functionality of the entire machine or plant.

The safety switchgear must be exclusively used in accordance with the versions listed below or for the applications authorised by the manufacturer. Detailed information regarding the range of applications can be found in the chapter "Product description".

**1.5 General safety instructions**

The user must observe the safety instructions in this operating instructions manual, the country specific installation standards as well as all prevailing safety regulations and accident prevention rules.



Further technical information can be found in the Schmersal catalogues or in the online catalogue on the Internet: [products.schmersal.com](http://products.schmersal.com).

The information contained in this operating instructions manual is provided without liability and is subject to technical modifications.

There are no residual risks, provided that the safety instructions as well as the instructions regarding mounting, commissioning, operation and maintenance are observed.

### 1.6 Warning about misuse



In case of improper use or manipulation of the safety switchgear, personal hazards or damages to machinery or plant components cannot be excluded.

### 1.7 Exclusion of liability

We shall accept no liability for damages and malfunctions resulting from defective mounting or failure to comply with this operating instructions manual. The manufacturer shall accept no liability for damages resulting from the use of unauthorised spare parts or accessories.

For safety reasons, invasive work on the device as well as arbitrary repairs, conversions and modifications to the device are strictly forbidden, the manufacturer shall accept no liability for damages resulting from such invasive work, arbitrary repairs, conversions and/or modifications to the device.

## 2. Product description

### 2.1 Ordering code

This operating instructions manual applies to the following types:

		EX-I-RS655	EX-RS655-2D	EX-RS655
<b>Zone</b>	Zone 1 gas	x		x
	Zone 21 dust	x	x	x
<b>Ignition protection type</b>	Ex de, gas			x
	Ex t, dust	x	x	x
	Ex i, gas (associated apparatus)	x		x
	Ex i, dust (associated apparatus)	x		x
<b>Construction</b>	Terminal block	x	x	
<b>Communication</b>	Dupline		x	

#### EX-I-RS655-Z22<sup>①</sup>

No.	Option	Description
①		Contacts silver-plated (included in standard version)
	A1	Gold flashed contacts 0.3 µm
	A2	Gold flashed contacts 1.0 µm
	A3	Gold flashed contacts 3.0 µm

EX-I-RS655-Z22 can be installed in both gaseous and dusty atmospheres when ignition protection type Ex i (intrinsic safety) is used. This requires associated apparatus.

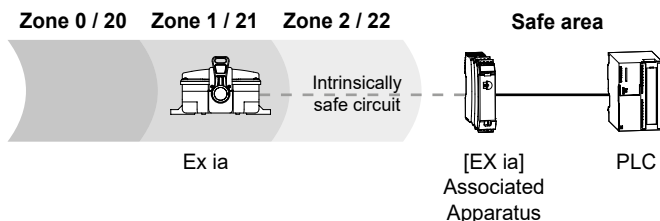

EX-I-RS655-Z22 can be used in dusty atmospheres without associated apparatus for Ex i if ignition protection type Ex t (protection by enclosure) is used.

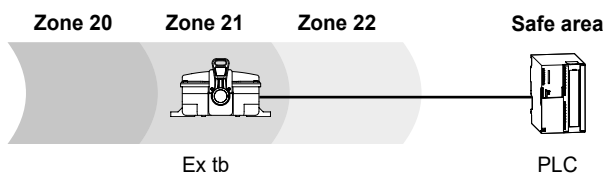

#### EX-RS655-T22<sup>①</sup>

No.	Option	Description
①		Contacts silver-plated (included in standard version)
	A1	Gold flashed contacts 0.3 µm
	A2	Gold flashed contacts 1.0 µm
	A3	Gold flashed contacts 3.0 µm

EX-RS655-Z22 is especially suited to gaseous atmospheres and requires no associated apparatus.

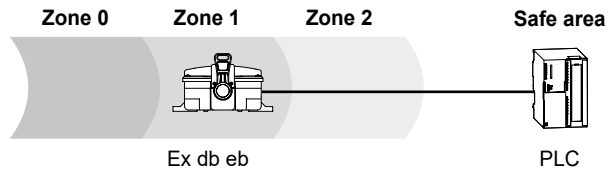

#### EX-RS655-Z22<sup>①-②-2D</sup>

Version with integrated DuplineSafe<sup>®</sup> or Dupline<sup>®</sup> input module

No.	Option	Description
①		Contacts silver-plated (included in standard version)
	A1	Gold flashed contacts 0.3 µm
	A2	Gold flashed contacts 1.0 µm
	A3	Gold flashed contacts 3.0 µm
②	DS	With integrated DuplineSafe <sup>®</sup> input module
	DN	With integrated Dupline <sup>®</sup> input module

EX-RS655-...-2D offers communication via Dupline<sup>®</sup>. The device may only be used in dusty atmospheres if ignition protection type Ex t (protection by enclosure) is used.

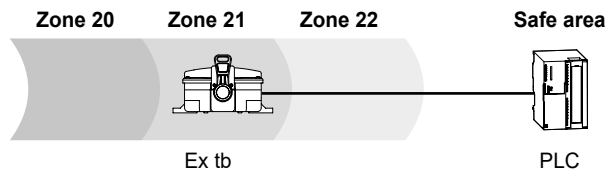

Only if the information described in these operating instructions are realised correctly can the safety function and therefore the compliance with the Machinery/Explosion Protection Directive be maintained.

### 2.2 Special versions

For special versions, which are not listed in the ordering code below 2.1, these specifications apply accordingly, provided that they correspond to the standard version.

### 2.3 Determination and use for functional safety

Pull-wire emergency stop switches are used wherever it must be possible to initiate the emergency stop command from any point on a machine, equipment or plant. The emergency stop command is triggered by pulling on the tensioned pull-wire.

The two-sided pull-wire emergency stop switch has pull-wire and wire-breakage monitoring. On pulling or breakage of the wire, the NC contacts are positively opened and the NO contacts are closed. Thereafter the pull-wire emergency switch can only be manually set back into an operational state. The device is suitable for harsh environmental conditions.

The versions with ordering suffix -DS and -DN are equipped with a network-capable DuplineSafe<sup>®</sup> or Dupline<sup>®</sup> input module.

#### DuplineSafe<sup>®</sup>

The emergency stop signal is transmitted by means of the DuplineSafe<sup>®</sup> input module via the Dupline<sup>®</sup> 2-wire installation bus to a safety relay, which safely switches off downstream devices.



After installing the DuplineSafe® input module, its technical data and safety parameters for the whole device must be observed. For details, please refer to the operating instructions of the DuplineSafe® input module in the online catalogue at [products.schmersal.com](http://products.schmersal.com).

## 2.4 Determination and use for explosion protection

The EX-I-RS655 version without DuplineSafe® or Dupline® input module can also be installed in gaseous atmospheres of zones 1 and 2, category 2G and 3G, when the intrinsic safety Ex i ignition protection type is used as well as in dusty atmospheres in zones 21 and 22, category 2D and 3D.

When ignition protection type Ex tb (protection by enclosure) is used, the device can also be installed in potentially explosive dust atmospheres without associated electrical equipment.

The switch may only be operated in the temperature range specified in the datasheet. External influences, e.g. solar radiation, external sources of cold, must be borne in mind and precautionary measures taken, if applicable.



During installation in intrinsically safe current circuits (Ex i), it must be borne in mind that the device may only be connected to a single, approved electrical apparatus (e.g. SRB 200EXi-..., barrier, isolated switch amplifier). The safety data of both devices must be compared.



The version with integrated DuplineSafe® or Dupline® input module is only certified for use in potentially explosive dust atmospheres of zones 21 and 22, category 2D and 3D.

The installation and maintenance requirements to the standard series 60079 must be met.



Cable glands and locking screws (not included in delivery) must be suitable for potentially explosive areas. Appropriate accessories can be found in the electrical connection chapter of the Schmersal catalogues or in the online catalogue on the internet: [products.schmersal.com](http://products.schmersal.com).



The entire concept of the control system, in which the safety component is integrated, must be validated to the relevant standards.

The safety-technical data and features according to the applicable test certificate (or possible other approvals) are mentioned in the technical data.

## 2.5 Technical data

### EX-I-RS655:

Marking in accordance with the ATEX Directive:	⊕ II 2G ⊕ II 2D
Marking in accordance with standards:	Ex ia IIC T6 Gb Ex ia IIIC T85°C Db Ex tb IIIC T85°C Db
Applied standards:	EN 60947-5-1, EN 60947-5-5, EN ISO 13850, EN 620
- ATEX:	EN IEC 60079-0, EN 60079-11, EN 60079-31
- IECEX:	IEC 60079-0, IEC 60079-11, IEC 60079-31
- CCC-Ex, NEPSI:	GB/T 3836.1, GB/T 3836.4, GB/T 3836.31
Certificate numbers:	
- ATEX:	TÜV 19 ATEX 8428
- IECEX:	IECEX TUR 19.0061
- CCC-Ex:	2021322304003983
- NEPSI:	GYJ21.1694

### EX-RS655:

Marking in accordance with the ATEX Directive:	⊕ II 2G ⊕ II 2D
Marking in accordance with standards:	Ex db eb IIC T6 Gb Ex tb IIIC T85°C Db Ex ia IIC T6 Gb Ex ia IIIC T85°C Db
Applied standards:	EN 60947-5-1, EN 60947-5-5, EN ISO 13850, EN 620
- ATEX:	EN IEC 60079-0, EN 60079-1, EN IEC 60079-7, EN 60079-11, EN 60079-31
- IECEX:	IEC 60079-0, IEC 60079-1, IEC 60079-7, IEC 60079-11, IEC 60079-31
- CCC-Ex, NEPSI:	GB/T 3836.1, GB/T 3836.2, GB/T 3836.3, GB/T 3836.4, GB/T 3836.31
Certificate numbers:	
- ATEX:	TÜV 19 ATEX 8428
- IECEX:	IECEX TUR 19.0061
- CCC-Ex:	2021322304003983
- NEPSI:	GYJ21.1694

### EX-RS655-...-DS-2D, EX-RS655-...-DN-2D:

Marking in accordance with the ATEX Directive:	⊕ II 2D
Marking in accordance with standards:	Ex tb IIIC T85°C Db
Applied standards:	EN 60947-5-1, EN 60947-5-5, EN ISO 13850, EN 620
- ATEX:	EN IEC 60079-0, EN 60079-31
- IECEX:	IEC 60079-0, IEC 60079-31
- CCC-Ex, NEPSI:	GB/T 3836.1, GB/T 3836.31
Certificate numbers:	
- ATEX:	TÜV 19 ATEX 8428
- IECEX:	IECEX TUR 19.0061
- CCC-Ex:	2021322304003983
- NEPSI:	GYJ21.1694

### General technical data:

Enclosure/cover:	Grey cast iron, painted
Degree of protection:	IP66, IP67 to EN 60529
Protection class:	I
Degree of pollution:	3
Contact material:	Silver
- Ordering suffix A1,A2,A3:	Gold-plated contacts 0.3 µm, 1 µm, 3 µm
Contact type:	change-over contact with double break Zb, max. 2 NO / 2 NC contacts
Switching system:	⊖ EN 60947-5-1 snap action (Z22) or slow action (T22), positive break NC contact
Cable entry:	2x M25
Ex cable gland:	⊕ II 2GD
Cable cross-section:	Ø 7 ... 12 mm
Termination:	
- EX-I-RS655:	Central termination block with cage clamps
- EX-RS655:	Switch element with screw terminals
- EX-RS655-...-2D:	Screw terminals on Dupline® board
Cable type:	rigid single-wire or flexible
Cable section:	0.75 ... 2.5 mm²
Tightening torque:	Cover screws: 3 Nm Earth screws: PE 1 Nm, PA 1.2 Nm
Rated impulse withstand voltage U <sub>imp</sub> :	4 kV
Rated insulation voltage U <sub>i</sub> :	300 V
Thermal test current I <sub>the</sub> :	6 A
Utilisation category:	DC-13, AC-15
Rated operating current/voltage I <sub>e</sub> /U <sub>e</sub> :	3 A / 24 VDC 3 A / 230 VAC
Max. fuse rating:	6 A gG D-fuse
Required short-circuit current:	400 A
Ambient temperature:	
- EX-RS655:	-25 °C ... +65 °C
- EX-I-RS655, EX-RS655-...-DN-2D / ...-DS-2D :	-25 °C ... +70 °C
Mechanical life:	100.000 operations
Maximum wire length:	2 x 100 m
Actuating force:	18 N
Features:	wire pull and breakage detection

### Divergent data for the DuplineSafe® (DS)/Dupline® (DN) version:

Supply voltage:	8.2 VDC
Power consumption:	
-DuplineSafe® (DS):	1.0 mA
-Dupline® (DN):	100 µA
Device insulation:	internal short-circuit proof
Rated impulse withstand voltage $U_{imp}$ :	800 V
Rated insulation voltage $U_i$ :	30 VDC
Cable type:	rigid single-wire or flexible
Cable section:	
- Rigid single wire:	0.2 ... 4 mm <sup>2</sup>
- Flexible:	0.25 ... 2.5 mm <sup>2</sup>
	(with conductor ferrule)

### 2.6 Safety classification

Standards:	EN ISO 13849-1
$B_{10D}$ (NC contact):	100,000
Mission time:	20 years

$$MTTF_D = \frac{B_{10D}}{0,1 \times n_{op}} \quad n_{op} = \frac{d_{op} \times h_{op} \times 3600 \text{ s/h}}{t_{cycle}}$$

(Determined values can vary depending on the application-specific parameters hop, dop and tcycle as well as the load.)



If multiple safety components are wired in series, the Performance Level to EN ISO 13849-1 will be reduced due to the restricted error detection under certain circumstances.  
**Series-wiring for devices in ignition protection type is not permitted.**

### 2.7 Safety-technical data – Intrinsic safety

For explosion protection with intrinsic safety ignition protection type (Ex i), the switchgear must be wired with suitable associated equipment. Associated electrical equipment is suitable only if the safety-technical data for the device are consistent in accordance with the "verification of intrinsic safety".

Safety-technical data – Intrinsic safety*		Comparison of safety-technical data*	
Voltage $U_i$ :	60 V	$U_i \geq U_o$	
Current $I_i$ :	100 mA	$I_i \geq I_o$	
Power $P_i$ :	6 W	$P_i \geq P_o$	
Capacity $C_i$ :	0	$C_i + C_{cable} \leq C_o$	
Inductivity $L_i$ :	0	$L_i + L_{cable} \leq L_o$	

\*  $U_o$ ,  $I_o$ ,  $P_o$ ,  $C_o$ ,  $L_o$  can be found in the documentation for the associated equipment.

## 3. Mounting

### 3.1 General mounting instructions



The installation may only be carried out with the system de-energised and by authorised personnel.

The pull-wire emergency stop switch must be fitted in the middle of the plant. Two mounting holes are available. Mount the pull-wire emergency stop switch so that the device can be unlocked and reset by hand after an emergency stop command.



Please observe the information on tightening torques in the technical data.



In accordance with EN 60947-5-5 (EN 620), the maximum perpendicular traction force to be exercised on the wire in order to activate the emergency pull-wire switch is 200 N (125 N), the maximum deflection is 400 mm (300 mm). Sufficient space must be provided so that the required actuating deflection can be reached.

It must be ensured that when tensioned, the wire rope always follows a straight course and that it remains in the correct position at all times (including at the redirection point). External influences (temperature variations, ageing) can affect the properties of the wire rope. The information in EN ISO 13850 must be observed.

### 3.2 Dimensions

All measurements in mm.

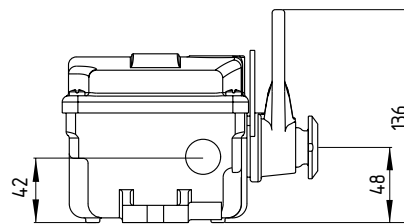
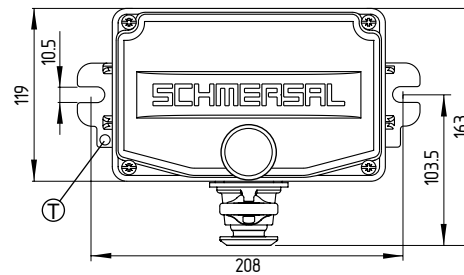
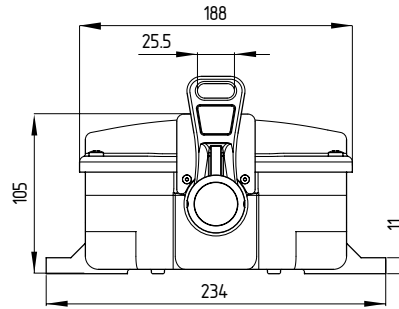

3.3 Pull wire system accessories

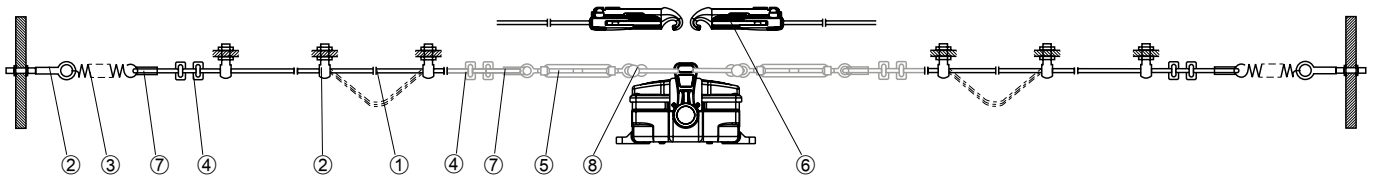

Equip the wire rope ① at the connection points with a thimble ⑦ and two wire clamps ④. The first wire clamp must be installed immediately behind the thimble. The PVC sheath of the pull wire must be stripped in the thimble area. Adjust the pre-tension of the springs ③ by means of the tensioning jack ⑤/rope tensioner ⑥ so that the lever is in the middle position and the counterside triggers the emergency stop command in case of breakage of the wire rope. The tension spring contains elongation protection.

As the thimbles are subject to deformation in case of wire pull, the wire should be pulled several times after fitting. After that, the wire must be re-tensioned.

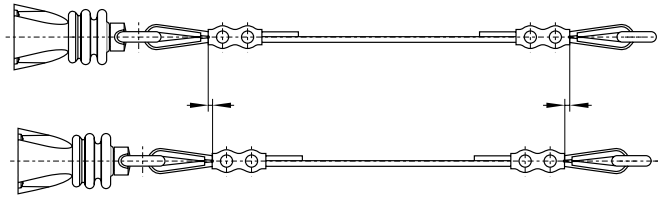

Image: Thimble deformation



Switch travel x: max. 400 mm (300 mm to EN 620),  
distance between support points L: max. 3 m



The greyed out components ④, ⑤, ⑦ and ⑧ are not required  
if using the rope tensioner S 900.

No.	Description	Designation	Ordering code	Details
①	Wire rope	PWR-xM	on request	Red PVC sheath, steel core Ø 3 mm, Total diameter 5 mm
②	Eyebolt (incl. nut) Anchoring hook (incl. 2 nuts and washers)	ACC-PWR-EBLT-BM8X70-A2 ACC-PWR-EBLT-BM10X40 ACC-EBLT-M8-RVA-5PCS ACC-EBLT-M10-RVA-5PCS ACC-EBLT-M8-5PCS ACC-EBLT-M10-5PCS	101192471 101084928 103031496 103031499 103031495 103031498	Stainless steel, steel, galvanised Stainless steel, 5 Stainless steel, 5 Galvanised steel, 5 Galvanised steel, 5
③	Tension spring	ACC-RS65X-TS	103032772	Stainless steel with elongation limiter
④	Wire clamp	ACC-PWR-RC-3MM-NIRO ACC-PWR-RC-5MM-NIRO	101203477 101203478	Stainless steel, Ø 3 mm Stainless steel, Ø 5 mm
⑤	Tensioning Jack	ACC-TBLE-RVA ACC-PWR-TB-M6-2	103031494 101087930	M8 (stainless steel), 180 to 250 mm M6 (steel, galvanised), 145 to 225 mm
⑥	Rope tensioner	S 900	101186704	Smooth and time-saving adjustment
⑦	Wire thimble	ACC-PWR-WT-3MM-NIRO ACC-PWR-WT-5MM-NIRO	101203472 101203476	Stainless steel, Ø 3 mm Stainless steel, Ø 5 mm
⑧	Shackle	ACC-PWR-SKL-A0,16-VA	101186490	Bracket with threaded bolt, stainless steel
⑨	Mounting set, double-sided Mounting set, double-sided with quick-clamping system S 900	ACC-RK-RS65X ACC-RK-RS65X-QR	103036965 103036963	2x ②, ③, ⑤ and 4x ⑦, ⑧ and 8x ④ in each case 2x ②, ③, ⑥, ⑦ and 4x ④ in each case

Other accessories

Description	Designation	Ordering code
Actuating handle	ACC-PWR-HDL	103042171
Pulley	ACC-PWR-PLY	103037516
Marking flag	ACC-PWR-ESLB-50PCS	103032469

### 4. Electrical connection

#### 4.1 General information for electrical connection



The electrical connection may only be carried out by authorised personnel in a de-energised condition.



To prevent damage to the cable due to mechanical influences, the routing of a cable reserve in the free space under the switch insert cover is not permitted.

Once wired, fit the housing cover and tighten the screws evenly (tightening torque 3 Nm).



Connection to the external equipotential bonding terminal must be carried out in accordance with EN 60079-14 section 6.3.

#### 4.2 Contact Options

All NC contacts have positive break ⊖.

#### 2 NO / 2 NC

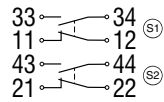

#### Legend:

Ⓢ<sub>1</sub>, Ⓢ<sub>2</sub> Switch insert S1, S2

#### 4.3 Accessories for cable entry



Only use EX cable glands/wire entries approved for the respective area of application and EX stopping plugs with integrated or associated seal. Assemble the cable gland/wire entry according to the applicable operating instructions. The cable gland is only permitted for permanent cables and wires. The person responsible for installation must ensure the necessary strain relief. Seal off all unused wire entries with EX-approved stopping plugs. Cable glands and stopping plugs are not included.

Accessories for cable entry (not included in delivery)	Ordering code	Tightening torque
Ex cable gland with counternut, stainless steel	101204779	12 Nm
Ex stopping plug, nickel-plated brass	101205617	8 Nm



Always use the cable gland in accordance with the requisite conductor.

#### 4.4 Connector EX-I-RS655

In the as-delivered condition, the two normally-closed contacts and the two normally-open contacts are positioned on one side of the central connection terminal strip. The other side of the terminal strip is for the user-side connection.

The connection diagram for all versions with central connection terminal can be found in the cover of the switch. In addition to the switch contacts, terminals ("signal return") are also available for return of the signal lines when series-wiring is used.

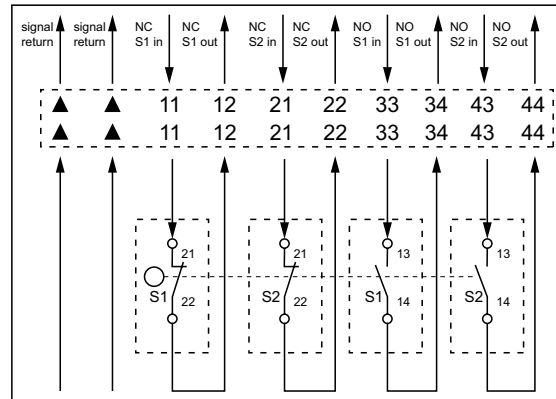

The series has a closed switching insert cover for the selector shaft, cams and switching contacts. The switching insert cover must be used and, in addition to the constructive cable routing, also serves as protection against dust and dirt.

In the as-delivered condition, the two normally-closed contacts and the two normally-open contacts are positioned on one side of the central connection terminal strip. The other side of the terminal strip is for the user-side connection.

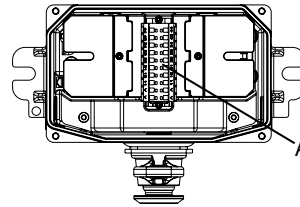

A: Central connection terminal strip

#### Settle length x of the conductor:

- at terminals of type s or f: 8 ... 9 mm
- at the equipotential bonding terminal: 9 mm



#### 4.5 Connector EX-RS655

Once the wiring has been completed at switch elements S1 and S2, the switching insert cover must be used which, in addition to the constructive cable routing, also serves as protection against dust and dirt.

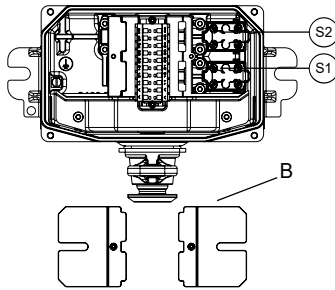

**B:** Switch insert covers  
Ⓢ1, Ⓢ2 : Switch insert S1, S2

#### Settle length x of the conductor:

- on screw terminals: 8 mm
- at the equipotential bonding terminal: 9 mm



#### 4.6 Connector EX-RS655-...-DS-2D / EX-RS655-...-DN-2D

Before electrical installation, the Dupline®/DuplineSafe® input module must be addressed and parametrised in accordance with the specifications of Dupline® (www.dupline.com). Release the connector on the circuit board with Dupline® input module connection and connect it to the programming device with the aid of the ACC-PRGC-DN programming cable. After successful addressing, the connector must be plugged back into the address bar.

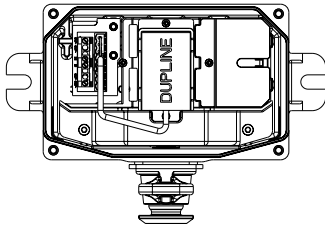

Connect the wires of the DuplineSafe® installation bus to the on the circuit board dedicated terminals marked with DUP+ / DUP- (tightening torque 0.6 Nm). The terminals on the opposite side marked with DUP+ / DUP- serve to connect the next Dupline® bus subscriber.

#### Settle length x of the conductor:

- at the terminals of the Dupline® board: 8 mm
- at the equipotential bonding terminal: 9 mm



The normally-closed contacts of the switch elements are connected to the Dupline® terminal block in the as-delivered condition.

For correct operation, the installation regulations of the Dupline® input module must be observed. For supply and also addressing of the Dupline® input modules, the following Dupline® system components are required.

#### 4.7 System components DuplineSafe®

System components DuplineSafe®	Ordering code
DuplineSafe® configuring and testing unit GS73800080	103010115
Dupline® master channel generator SD2DUG24	103033128
DuplineSafe® safety relay GS38300143 230	103010174
Cable termination DT01	103010203

#### 4.8 System components Dupline®

System components Dupline®	Ordering code
Hand-held programming device GAP1605	103010199
Test unit GTU8	103013800
Programming cable ACC-PRGC-DN	103033601
Dupline® master channel generator SD2DUG24	103033128
Cable termination DT01	103010203

## 5. Set-up and maintenance

### 5.1 Functional testing

The safety function of the safety components must be tested. The following conditions must be previously checked and met:

1. The mounting is executed according to the instructions.
2. The cable is correctly executed and connected.
3. The connection is executed correctly.
4. Remove particles of dust and soiling.
5. Check the functionality of the switch by actuating the wire.

### 5.2 Maintenance

In case of correct installation in accordance with the above-described instructions, the component requires little maintenance. For use in extreme conditions, we recommend routine maintenance including the following steps:

1. Check for damages and correct fixing.
2. Remove particles of dust and soiling.
3. Check the correct fixing of the cover screws.
4. Check cable entry and connections in a de-energised condition
5. Check the free movement of the actuating element.
6. Check the correct latching after actuation of the pull-wire emergency stop switch.
7. Check the wire rope (and any redirection rollers) for damage and correct seating.



Avoid electrostatic charging. Clean with damp cloth.  
Do not open the device under tension.

**For explosion protection reasons, the component must be exchanged after max. 100,000 operations.**

**Damaged or defective components must be replaced.**

## 6. Disassembly and disposal

### 6.1 Disassembly

The safety switchgear must be disassembled in a de-energised condition only.

### 6.2 Disposal

The safety switchgear must be disposed of in an appropriate manner in accordance with the national prescriptions and legislations.

7. EU Declaration of conformity

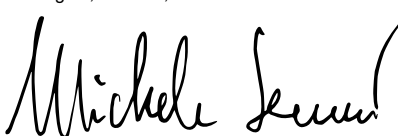
EU Declaration of conformity			
Original	SCHMERSAL Industrial Switchgear (Shanghai) Co., Ltd. Cao Ying Road 3336 201712 Shanghai / Qingpu P.R. CHINA <a href="http://www.schmersal.com.cn">http://www.schmersal.com.cn</a>		
We hereby certify that the hereafter described components both in their basic design and construction conform to the applicable European Directives.			
<b>Name of the component:</b>	EX-I-RS655 <sup>1)</sup>	EX-RS655 <sup>2)</sup>	EX-RS655-...-DS-2D <sup>3)</sup> EX-RS655-...-DN-2D <sup>3)</sup>
<b>Marking:</b>	<ul style="list-style-type: none"> <li>⊕ II 2G Ex ia IIC T6 Gb</li> <li>⊕ II 2D Ex ia IIIC T85°C Db</li> <li>⊕ II 2D Ex tb IIIC T85°C Db</li> </ul>	<ul style="list-style-type: none"> <li>⊕ II 2G Ex db eb IIC T6 Gb</li> <li>⊕ II 2D Ex tb IIIC T85°C Db</li> <li>⊕ II 2G Ex ia IIC T6 Gb</li> <li>⊕ II 2D Ex ia IIIC T85°C Db</li> </ul>	<ul style="list-style-type: none"> <li>⊕ II 2D Ex tb IIIC T85°C Db</li> </ul>
<b>Type:</b>	See type code		
<b>Description of the component:</b>	Pull-wire emergency stop switch for safety function or pull-wire emergency stop switch <sup>3)</sup> optionally with Dupline® or DuplineSafe® input module		
<b>Relevant Directives:</b>	Machinery Directive	2006/42/EC	
	Explosion Protection Directive (ATEX)	2014/34/EU	
	<sup>3)</sup> EMC Directive	2014/30/EU	
	RoHS-Directive	2011/65/EU	
<b>Applied standards:</b>	EN 60947-5-1:2017 + AC:2020, EN 60947-5-5:1997 + A1:2005 + A11:2013 + A2:2017, EN ISO 13850:2015, EN ISO 13849-1:2015 <sup>1)</sup> EN IEC 60079-0:2018, EN 60079-11:2012, EN 60079-31:2014 <sup>2)</sup> EN IEC 60079-0:2018, EN 60079-1:2014, EN IEC 60079-7:2015 + A1:2018, EN 60079-11:2012, EN 60079-31:2014 <sup>3)</sup> EN IEC 60079-0:2018, EN 60079-31:2014		
<b>Notified body, which approved the full quality assurance system, referred to Appendix IV, 2014/34/EU and for the ATEX certification:</b>	TÜV Rheinland Industrie Service GmbH Am Grauen Stein, 51105 Köln ID n°: 0035		
<b>EU type examination certificate:</b>	TÜV 19 ATEX 8428		
<b>This certificate refers only to the certification of the products in accordance with the Explosion Protection Directive 2014/34/EU (ATEX). Product conformity in accordance with the Machinery Directive 2006/42/EC is declared by the manufacturer under its own responsibility.</b>			
<b>Person authorised for the compilation of the technical documentation:</b>	Oliver Wacker Möddinghofe 30 42279 Wuppertal		
<b>Place and date of issue:</b>	Shanghai, June 28, 2023		
	 Authorised signature <b>Michele Seassaro</b> Managing Director		

EX-RS655-D-EN



The currently valid declaration of conformity can be downloaded from the internet at [products.schmersal.com](http://products.schmersal.com).



**K.A. Schmersal GmbH & Co. KG**  
Möddinghofe 30, 42279 Wuppertal  
Germany  
Phone: +49 202 6474-0  
Fax: +49 202 6474-100  
E-Mail: [info@schmersal.com](mailto:info@schmersal.com)  
Internet: [www.schmersal.com](http://www.schmersal.com)

**Production site:**  
**Schmersal Industrial Switchgear (Shanghai) Co., Ltd.**  
No. 3336 Cao Ying Road  
Qingpu, Shanghai, P.R.China  
Zip code: 201712  
Phone: +86 21 63758287  
Fax: +86 21 69214398  
E-Mail: [www.schmersal.com.cn](http://www.schmersal.com.cn)

施迈赛工业开关制造（上海）有限公司  
上海市青浦区漕盈路3336号  
邮编: 201712  
电话: 021 63758287  
传真: 021 69214398  
网址: [www.schmersal.com.cn](http://www.schmersal.com.cn)