

ONE

— INTEGRATED —
SOLUTION

for Control & Automation

- **Motion Control**
- **Full range of PLCs**
- **Powerful Software**
- **Cloud Solution**

Motion Catalogue



Unitronics

Solutions that Simplify Complex Tasks

Founded in 1989, Unitronics designs, manufactures, and markets advanced control and automation solutions. Our goal is to simplify complex tasks in automation.

Our extensive offering includes complete lines of PLCs, AC Servo Drives & Motors, VFDs, a broad array of I/Os and complementary devices, programming software for all aspects of control, motion, HMI, and communications—and an end-to-end IIoT platform designed specifically for machine builders.

Today, our field-proven products automate hundreds of thousands of installations in diverse fields, including petrochemicals, automotive, food processing, plastics & textiles, energy & environment, water & waste water management – anywhere automated processes are required.

Represented by more than 180 distributors in over 55 countries around the globe, Unitronics customers receive local support in their local languages.

Unitronics Benefits - One Integrated Solution for Control & Automation

- **One Contact** for Sales, Service, and Support
- **Customized Products** to your specifications
- **Award-winning Software** included with any purchase
- **24/7 Support** - at no charge
- **UniCloud:** Unitronics' Do-it-Yourself IIoT Cloud platform, designed for Machine Builders
- **Integrate easily** any device via communications

One Integrated Solution for Control and Automation	4
Motion Solution: Simple to set up. Painless to program	6
AC Servo: Drives & Motors	8
Variable Frequency Drives: Ideal for machines & process control	14
UniCloud: Complete, no-code IIoT cloud platform	20



Programmable Logic Controllers - For information on our full lines of PLC's & Accessories, refer to our Controllers catalogue.

This catalog provides a general overview of Unitronics products. Before you place an order, please check the complete technical specifications for each product, located in the Unitronics website.

One Integrated Solution for Control & Automation

One Integrated Solution means that all components work together perfectly, every time. Unitronics' hardware—PLC, HMI, I/Os, VFDs, AC Servos, and more—is backed by All-In-One software. Efficiently program all aspects of configuration, control, motion, HMI/Web design—easily integrate UniCloud and avoid dealing with multiple suppliers.

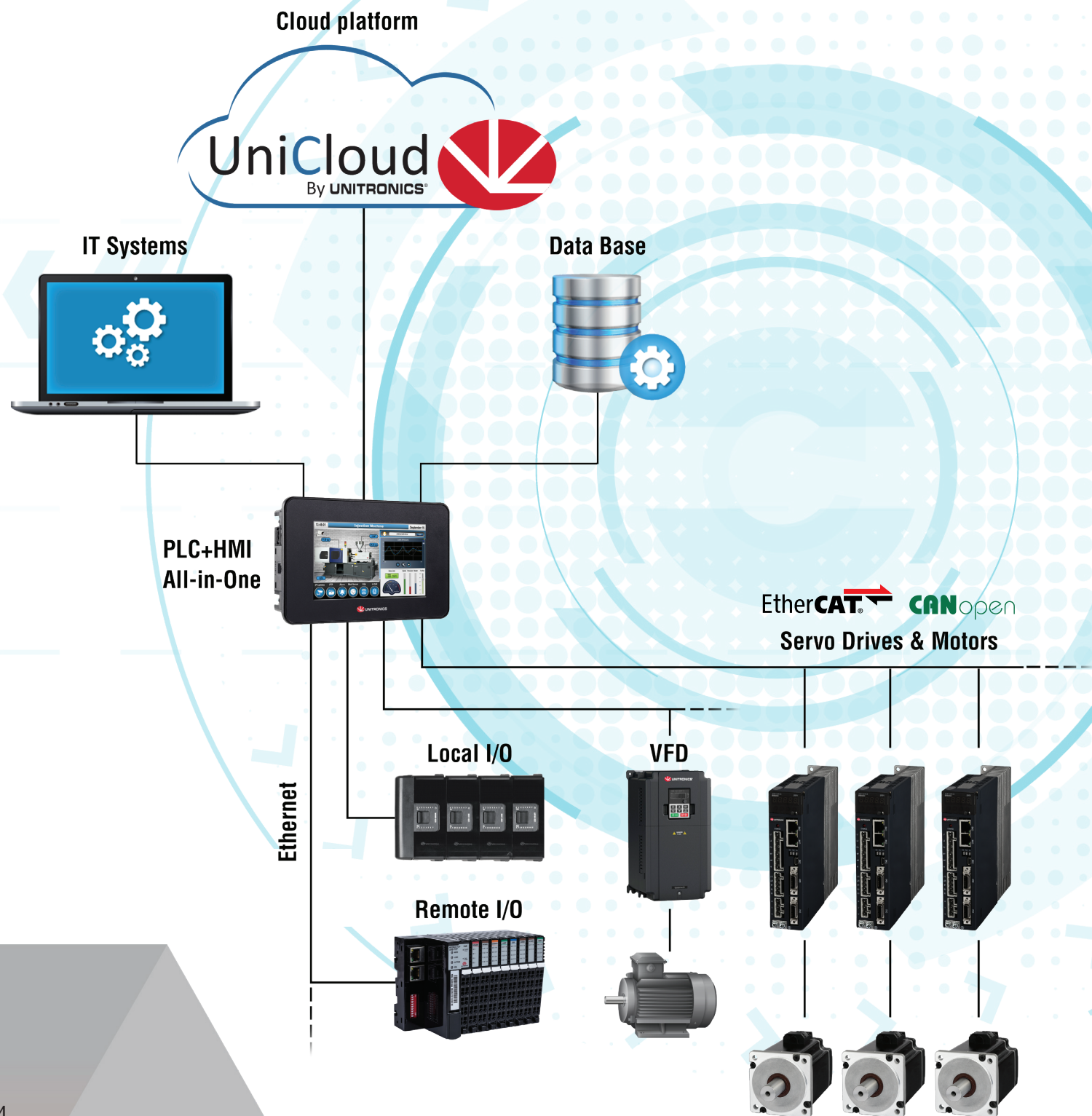

Motion Control: Full lines of VFDs & Servos

Motion made Simple

- Automatic, transparent setup
- Built-in Diagnostics
- Communications: effortless, seamless with Unitronics products
- VFDs: high performance, cost-effective
- Servos: Servo made Simple--Ready-made Motion code, PLCopen

Controllers: a Complete Range

PLC + HMI, PLC, Cloud Controllers

(See our Controllers catalogue)

- UniStream® Series - For easy execution of challenging projects
- UniStream® Cloud - Controllers with embedded cloud services
- Vision™ series - For advanced machines & automation projects
- Samba™ Series - Ideal for small machines that require graphic display
- Jazz® - Great for simple control

All-in-One Programming Software

At no extra charge

- Program Ladder Logic
- Design HMI & Web pages
- Motion—perform all tasks
- Hardware & Communication Configuration
- One Powerful Programming Environment

No-code IIoT Cloud Platform: UniCloud

Designed for Machine Builders

- Increase Profit: analyze data to reduce costs
- Secure
- Simple - No knowledge of IT needed
- Get up and running within 30 minutes



Motion Control with Unitronics Easy to set up. Painless to program.

Servo Drive and Motors & VFD

- **One Software:** Why struggle with multiple software tools to build your application? Unitronics provides one integrated software environment to control it all: PLC, HMI, Servo, VFD, and I/O
- **Automatic** communication setup: absolutely seamless
- **Minimal room for error:** UniLogic software analyzes mechanical properties and recommends safe values for your Servo and VFD Motion applications
- **Diagnostics:** View servo and VFD run-time performance via UniLogic's built-in powerful, high-speed scope
- **Single Parameter Tuning:** For both Servo and VFD
- **No coding needed!** Use Ready-Made Motion code to test your completed system
- **Embedded Diagnostic tools: no PC needed.** Tap a panel - even mobile - to:
 - Set motion parameters
 - Monitor Axis behavior and I/Os
 - Execute movements, such as Point-to-Point, Jog, and Homing
- **Ready-Made Motion code: simply open and edit as needed**

No motion programming knowledge needed!



UniLOGIC[®] Studio Software:
Eliminates the complicated operations associated with Motion Control.

Powerful, award-winning software that enables you to do it all in one project:

- Configure all hardware: PLC, HMI, VFDs, Servo drives, motors, actuators
- Build PLC, HMI, and Motion applications
- Set up and implement all communications—including IIoT Cloud
- Remotely perform any task that doesn't require a screwdriver

Motion Control programming:
drag & drop function blocks

Test & view performance
via built-in powerful,
high-speed scope

Analyzes mechanical properties, and recommends safe values

Add Axes, drag & drop actuators; UniLogic automatically converts units

UniLogic automatically defines the correct configuration & sets up communications



Ready-Made Motion Code - Get moving immediately – No programming needed!

Download Ready-Made Motion code and tap a panel – even mobile – to:

- Set motion parameters
- Monitor Axis behavior and I/Os
- Execute movements, such as Point-to-Point, Jog, and Homing

Servo Drives & Motors

Servo Made Simple: we do the work for you

- Ready Made Motion Code
- Embedded Diagnostic Tools
- Safe Values Recommendation
- Automatic Communication Setup
- Tuning Using One Parameter

Everything you need for your Servo Solution:

Hardware

- Drives: single and three-phase, robotic cables available
- Wide servo power range – 50W to 5,000W (0.06-6.7 HP)
- Motors: to suit any machine size; robust, built-in high-resolution serial encoders
- (absolute: 23-bit , incremental: 20-bit), IP65
- Built-in communications: EtherCAT¹ or CANopen

Software

- Servo drives and Motors: simple setup
- Ready-made code: implement Motion in 2 clicks
- Motion Control programming: drag & drop function blocks
- Control up to 8 Axes
- One-parameter tuning
- Built-in Diagnostic tools

Product Offering



Servo drive	Voltage	Power (kW / HP)	Motor	Frame Size (MM)	Rated current (A)	Rated torque (NM / lb-in)	Peak current (A)	Peak torque (NM / lb-in)	Rated speed (RPM)	Max speed (RPM)	Encoder type (Incremental \ Absolute)
UMD-0000B-■3	1-Phase 220V	0.05 / 0.06	UMM-0000BA-■B4	40	0.9	0.159 / 1.4	3.3	0.557 / 4.92	3000	6000	Abs 23bit
UMD-0001B-■3		0.1 / 0.13	UMM-0001BA-■B4	60	3.3	0.318 / 2.81	4	1.11 / 9.82			Abs 23bit
UMD-0002B-■3		0.2 / 0.26	UMM-0002BA -B4 UMM-0002BN -B4		1.5	0.637 / 5.63	4.7	1.91 / 16.9			Inc 20bit
UMD-0004B-■3		0.4 / 0.53	UMM-0004BA -B4 UMM-0004BN -B4	2.9	1.27 / 11.23	9.2	3.82 / 33.8	Abs 23bit Inc 20bit			
UMD-0007C-■3	1-Phase 220V and 3-Phase 220V	0.75 / 1	UMM-0007CA -B4 UMM-0007CN -B4	80	5.1	2.39 / 21.15	16.1	7.16 / 63.36	3000	6000	Abs 23bit Inc 20bit
UMD-0010C-■3		1 / 1.34	UMM-0010CA -B4 UMM-0010CN -B4	6.9	3.18 / 28.14	19.5	8.8 / 77.88	Abs 23bit Inc 20bit			
UMD-0015C-■3		1.5 / 2.01	UMM-0015CA -B2 UMM-0015CN -B2	8.2	7.16 / 63.36	24.6	21.5 / 190.27	Abs 23bit Inc 20bit			
UMD-0020C-■3	3-Phase 220V	2 / 2.68	UMM-0020CA -B2 UMM-0020CN -B2	130	11.3	9.55 / 84.51	33.9	28.7 / 253.99	2000	3000	Abs 23bit Inc 20bit
UMD-0030C-■3		3 / 4.02	UMM-0030CA -B3 UMM-0030CN -B3	18	14.3 / 126.55	54	36.5 / 323.02	Abs 23bit Inc 20bit			
UMD-0050C-■3		5 / 6.7	UMM-0050CA -B3 UMM-0050CN -B2	28	23.9 / 211.51	84	54.3 / 480.55	Abs 23bit Inc 20bit			
UMD-0010E-■3	3-Phase 400V	1 / 1.34	UMM-0010EA -B2 UMM-0010EN -B2	130	3	4.78 / 42.3	9	14.3 / 126.55	2000	3000	Abs 23bit Inc 20bit
UMD-0015E-■3		1.5 / 2.01	UMM-0015EA -B2 UMM-0015EN -B2	4.3	7.16 / 63.36	12.9	21.5 / 190.27	Abs 23bit Inc 20bit			
UMD-0020E-■3		2 / 2.68	UMM-0020EA -B2 UMM-0020EN -B2	5.7	9.55 / 84.51	17.1	28.7 / 253.99	Abs 23bit Inc 20bit			
UMD-0030E-■3		3 / 4.02	UMM-0030EA -B3 UMM-0030EN -B3	8.8	14.3 / 126.55	26.4	36.5 / 323.02	Abs 23bit Inc 20bit			
UMD-0050E-■3	5 / 6.7	UMM-0050EA -B3 UMM-0050EN -B3	15	23.9 / 211.51	45	71.6 / 633.66	71.6 / 633.66	Abs 23bit Inc 20bit			

* All motors are offered with oil seal as standard
 Add the letter B in the square in order to include holding brake eg. UMM-0004BA- -B4 -> UMM-0004BAB-B4
 ■ For CANopen add B. For EtherCAT add E. UMD-0000B-■3 -> UMD-0000B-B3/UMD-0000B-E3

Product Designation Key

Drive

UMD - 0004	B	-	B3
①	②	③	④

No.	Key	Description
①	Product Line	Unitronics Servo Drive
②	Rated Power	0001: 100W 0010: 1KW
③	Input Voltage	B: 1PH 200V-230V C: 3PH 200V-230V E: 3PH 380V-440V
④	Product Series	B3- CANopen E3- EtherCAT

Cables

UMC	B4	FN	R	05
①	②	③	④	⑤

No.	Key	Description
①	Product line	Unitronics Servo Cable
②	Motor series	B2\B3\B4
③	Cable functionality	PN- Power cable without brake PB-Power cable with brake FA-Feedback cable absolute encoder FN-Feedback cable incremental encoder
④	Cable type	None: Standard cable R-Robotic cable
⑤	Cable length	03/05/10 Meters

Motor

UMM - 0004	B	N	B -	B4	
①	②	③	④	⑤	⑥

No.	Key	Description
①	Product Line	Unitronics Servo Motor
②	Rated Power	0001: 100W 0010: 1KW
③	Input Voltage	B: 1PH 200V-230V C: 3PH 200V-230V E: 3PH 380V-440V
④	Encoder	A: Absolute N: Incremental
⑤	Brake	None: No Brake B: With Brake
⑥	Product Series	B2/B3/B4

** UL certification is valid for all 220V products

Drive Specification



Input Power Supply	Main Circuit	200V	Single-Phase 200~230VAC (50W~1kW / 0.06 - 1.34HP)
		400V	Three-phase 200~230VAC (750W~5.0kW / 1.01 - 6.7HP)
	Control Circuit	200V	Single-Phase 200~230VAC (50W~5.0kW / 0.06 - 6.7HP)
		400V	24VDC (1~5.0kW / 1.34 - 6.7HP)
Control Method		SVPWM Control	
Feedback		20bit incremental encoder: 1048576 PRR 23bit Absolute encoder: 8388608 PRR	
Operating Conditions	Ambient Temperature	0~+55°C / 32~131°F	
	Storage Temperature	-25~+85°C / -13~185°F	
	Ambient/Storage Humidity	5%~95% RH (no condensation)	
	Elevation	Up to 1000m/3280ft	
	Vibration Resistance	4.9m/s ² / 0.5g	
Impact Resistance		19.6m/s ² / 2g	
Configuration		Wall mounted	
I/O Signals	8 Digital Inputs		
	4 Digital Outputs		
Other	Built-in regenerative resistor	750W~5.0kW / 1.01 - 6.7HP	
	Protection Functions	Overcurrent, overvoltage, low voltage, overload, regeneration error, overspeed	
	Display	CHARGE (Red), POWER (Green), 7-segment LEDES × 5 (Built-in digital panel operator)	
	Communication	EtherCAT/CANopen	

Servo Drive Dimensions

Power	200V	400V
(kW)	W×H×D(mm)	W×H×D(mm)
0.05	40X160X180	—
0.1	40X160X180	—
0.2	40X160X180	—
0.4	40X160X180	—
0.75	84X186X180	—
1.0	84X186X180	100X186X180
1.5	100X186X180	100X186X180
2.0	100X186X180	100X186X180
3.0	125X271X205	125X271X205
5.0	125X271X205	125X271X205

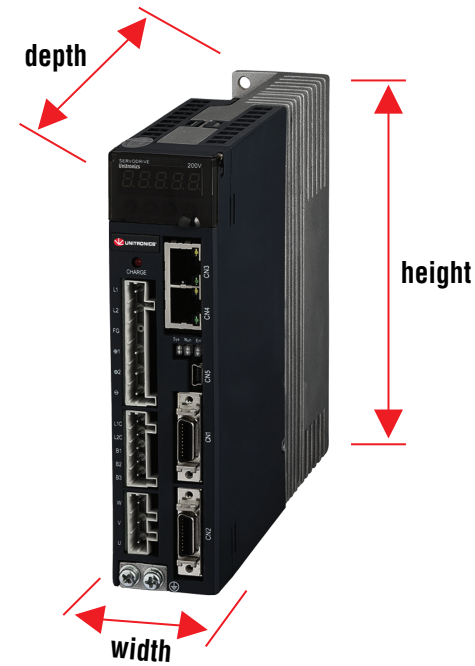

** UL certification is valid for all 220V products

Servo Motor Specification



		200 VAC		200 VAC				200 VAC			400 VAC					
		B4		B2		B3		B2		B3						
Rated Output Power	Kw / HP	0.05 / 0.06	0.1 / 0.13	0.2 / 0.26	0.4 / 0.53	0.75 / 1	1 / 1.34	1.5 / 2.01	2 / 2.68	3 / 4.02	5 / 6.7	1 / 1.34	1.5 / 2.01	2 / 2.68	3 / 4.02	5 / 6.7
Rated Torque	NM / lb-in	0.16 / 1.41	0.32 / 2.83	0.637 / 5.63	1.27 / 11.23	2.39 / 21.15	3.18 / 28.14	7.16 / 63.36	9.55 / 84.51	14.3 / 126.55	23.9 / 211.51	4.78 / 42.3	7.16 / 63.36	9.55 / 84.51	14.3 / 126.55	23.9 / 211.51
Peak Torque	NM / lb-in	0.48 / 4.24	0.96 / 8.49	1.91 / 16.9	3.82 / 33.8	7.16 / 63.36	8.8 / 77.88	21.5 / 190.27	28.7 / 253.99	36.5 / 323.02	54.3 / 480.55	14.3 / 126.55	21.5 / 190.27	28.7 / 253.99	36.5 / 323.02	71.6 / 633.66
Rated Current	A	0.6	1.1	1.5	2.9	5.1	6.8	8.2	11.3	18.0	28.0	3.0	4.3	5.7	8.8	15.0
Max Current	A	1.7	3.0	4.7	9.2	15.3	21.0	24.6	33.9	54.0	84.0	9.0	12.9	17.1	26.4	45.0
Rated Speed	RPM	3000						2000								
Max. Speed	RPM	6000						3000								
Rotor Moment of Inertia (with brake)	kg*cm ²	0.019 (0.05)	0.035 (0.052)	0.1469 (0.1794)	0.2435 (0.2759)	0.9094 (1.0655)	1.144 (1.3)	18.4 (19.5)	23.5 (24.6)	41.3 (44.5)	65.7 (68.9)	13.2 (14.3)	18.4 (19.5)	23.5 (24.6)	41.3 (44.5)	65.7 (68.9)
	lb-in ²	0.0065 (0.017)	0.012 (0.0177)	0.0501 (0.0613)	0.0832 (0.0942)	0.3107 (0.3640)	0.3909 (0.4442)	6.2875 (6.6634)	8.0303 (8.40621)	14.1128 (15.2063)	22.3824 (23.5442)	4.5106 (4.8865)	6.2875 (6.6634)	8.0303 (8.40621)	14.1128 (15.2063)	22.3824 (23.5442)
weight (with brake)	kg	0.374 (0.566)	0.508 (0.7)	0.9 (1.3)	1.3 (1.7)	2.6 (3.2)	3.1 (3.8)	8.9 (10.4)	10.8 (12.3)	16.63 (20.23)	24.3 (27.9)	7 (8.5)	8.9 (10.4)	10.8 (12.3)	16.63 (20.23)	24.3 (27.9)
	lb	0.82 (1.24)	1.12 (1.543)	1.984 (2.866)	2.866 (3.747)	5.732 (7.054)	6.834 (8.377)	19.621 (22.928)	23.81 (27.116)	36.662 (44.6)	53.572 (61.509)	15.432 (18.74)	19.621 (22.928)	23.81 (27.116)	36.662 (44.6)	53.572 (61.509)
Brake Rated Voltage		DC24V±10%														
Brake Rated Power	W	4.0		7.4		9.6		19.5		35.0		19.5		35.0		
Brake Holding Torque	NM / lb-in	0.318 / 2.814		1.5 / 13.276		3.2 / 28.322		12 / 106.209		40 / 354.03		12 / 106.209		40 / 354.03		
Incremental Encoder	PPR	-		20 bit (1,048,576)				20 bit (1,048,576)								
Absolute Encoder	PPR	23bit (8,388,609)						23 bit (8,388,608)								
Insulation class		F														
Ambient Temperature	°C / °F	0~+40°C / 32~+104°F (No freezing)														
Ambient Humidity	RH	20% to 80% non-condensing														
Enclosure		IP65 / NEMA4X														

* The values in parentheses are for servo motors with holding brakes

UMM-B4

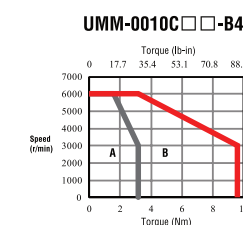
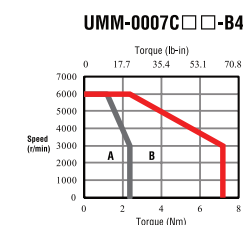
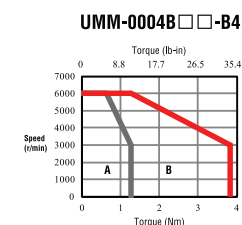
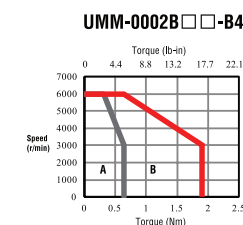
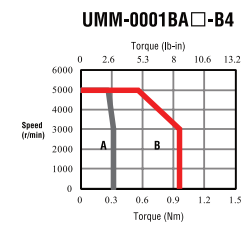
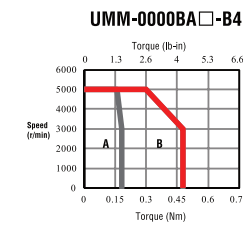

UMM-B2

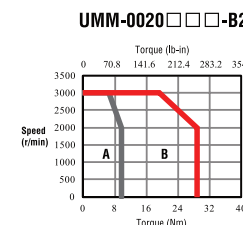
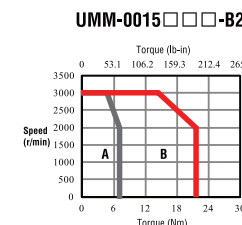
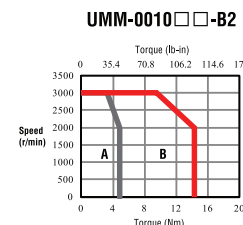

BMM-B3

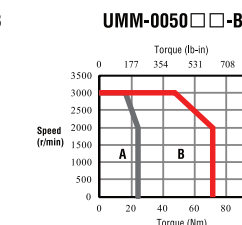
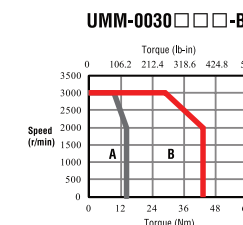

** UL certification is valid for all 220V products

UMM-B4: Motor Dimensions

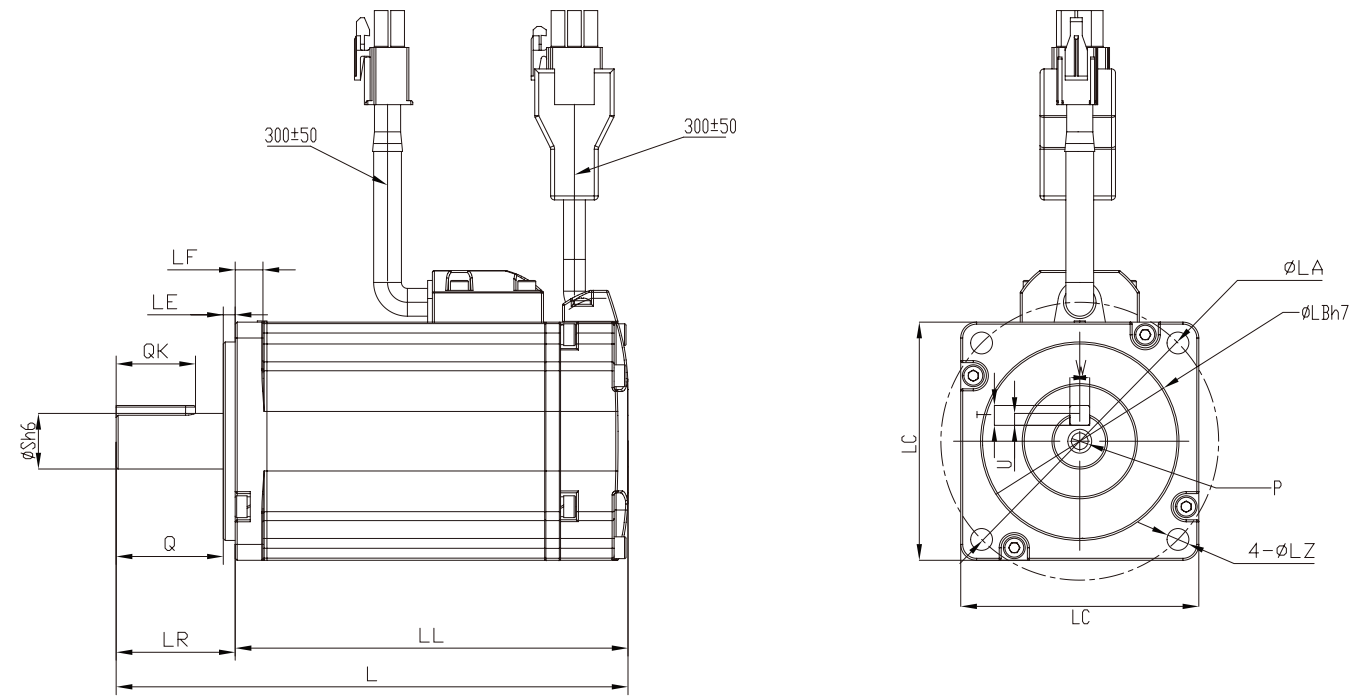

unit: mm

Part Number	L*	LL*	Flange Side							S	Tap x Depth	Key				
			LR	LE	LF	LC	LA	LB	LZ			QK	W	T	U	Q
UMM-0000BA -B4	92.5 (126)	62.5 (96)	25	2.5	5	40	46	30	4.3	8	M3X6	14	3	3	1.8	22.5
UMM-0001BA -B4	108.5 (142)	78.5 (112)														
UMM-0002BA -B4	108 (137)	78 (107)	30	3	7	60	70	50	6	14	M5x12	20	5	5	3	27
UMM-0004BA -B4	129 (158)	99 (128)														
UMM-0007CA -B4	141 (184)	111 (144)	40	3	8	80	90	70	7	19	M6x12	25	6	6	3.5	37
UMM-0010CA -B4	155 (198)	125 (158)														
UMM-0002BN -B4	126.5 (155.5)	96.5 (125.5)	30	3	7	60	70	50	5.5	14	M5x12	20	5	5	3	27
UMM-0004BN -B4	147.5 (176.5)	117.5 (146.5)														
UMM-0007CN -B4	159.5 (202.5)	129.5 (162.5)	40	3	8	80	90	70	7	19	M6x12	25	6	6	3.5	37
UMM-0010CN -B4	173.5 (216.5)	143.5 (176.5)														

*The values in parentheses are for servo motors with holding brakes
- Add the letter B in the square in order to include holding brake eg. UMM-0004BA -B4 -> UMM-0004BAB-B4

** UL certification is valid for all 220V products

UMM-B2 & UMM-B3: Motor Dimensions

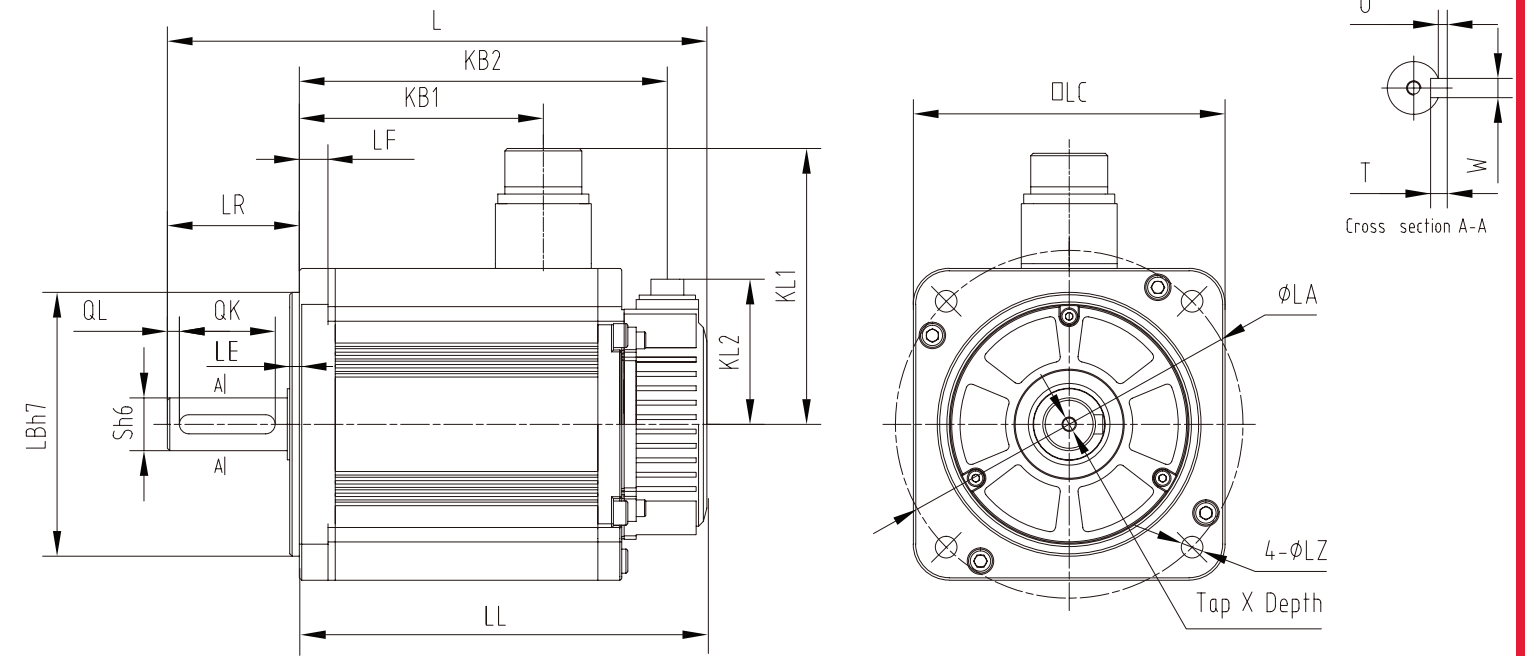

unit: mm

Part Number	L*	*LL	Flange Side							S	Tap x Depth	Key					KB1*	KB2*	KL1	KL2
			LR	LE	LF	LC	LA	LB	LZ			QK	QL	W	T	U				
UMM-0010EA -B2	203 (245.5)	148 (190.5)	55	4	12	130	145	110	9	22	M6x20	40	5	8	7	3	80 (103.2)	131.5 (174)	117	60.5
UMM-0015CA -B2	225 (267.5)	170 (212.5)															102 (125.2)	153.5 (196)		
UMM-0015EA -B2	225 (267.5)	170 (212.5)															102 (125.2)	153.5 (196)		
UMM-0020CA -B2	247 (289.5)	192 (234.5)															124 (147.2)	175.5 (218)		
UMM-0020EA -B2	247 (289.5)	192 (234.5)	79	3.2	18	180	200	114.3	13.5	35	M8x16	55	6	10	8	4.5	143	203 (274)	140	79
UMM-0030CA -B3	307 (378)	228 (299)															183	253 (324)		
UMM-0030EA -B3	307 (378)	228 (299)															183	253 (324)		
UMM-0050CA -B3	357 (428)	278 (349)	79	3.2	18	180	200	114.3	13.5	35	M8x16	55	6	10	8	4.5	183	253 (324)	140	79
UMM-0050EA -B3	357 (428)	278 (349)															183	253 (324)		

* The values in parentheses are for servo motors with holding brakes
- Add the letter B in the square in order to include holding brake eg. UMM-0010EA -B2 -> UMM-0010EAB-B2

** UL certification is valid for all 220V products

Variable Frequency Drives

High performance, cost-effective VFDs, ideal for both machines & process control

- Simple to use • Robust • Broad power & voltage range •

Features

- Options for both VFDs from 0.4 kW and up to 110 kW
- EMI Filters, Built-In
- Voltage Range: 220V - 480V
- Braking units - Built-in
- Heavy-Duty overload capacity, up to 200%
- Wide horsepower range: 0.5hp-150hp
- Coated PCBs: minimize dust penetration damage
- RS485: Modbus RTU Fieldbus
- Built-in Sensorless Control: Vector, Torque, Volts per Hz
- Safe Torque Off (STO)
- Mounting options: Wall, Flange, Rail
- Optional communication and I/O extension
- UL approved, TÜV-SÜD Safety and CE Certified



Use as a stand-alone product, or as part of a complete All-in-One package with our controllers

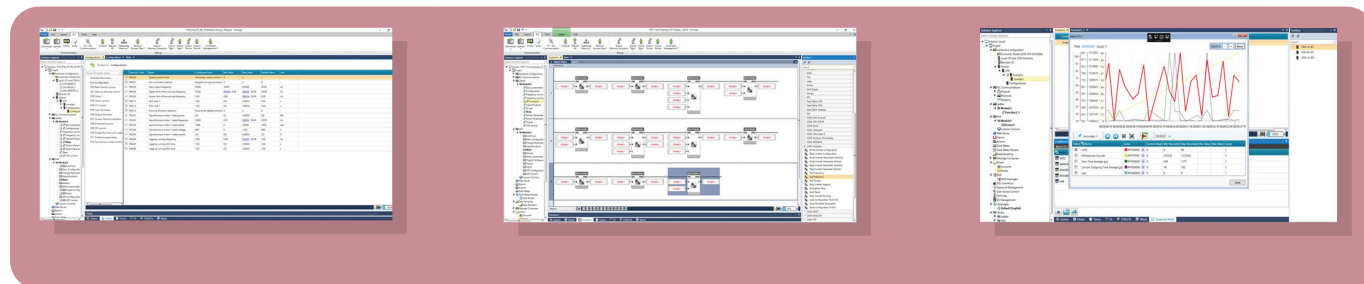

Product Specifications

		UMI-B1 EU	UMI-B5 UL
Power	Input Voltage	200-240VAC, Single Phase 380-440VAC, Three Phase	200-240VAC, Three Phase 380-480VAC, Three Phase
	Input Frequency	50/60Hz	
	Supported Motors	Asynchronous Induction Motors, Three Phase Input	Asynchronous Induction Motors, Three Phase Input Permanent Magnet Synchronous Motors, Three Phase Input
	Output Frequency	0-400Hz	
	Overload Capacity		150%, 60 seconds
		180%, 10 seconds	
		200%, 1 second	
Control	Control Method	SVPWM (Space Vector PWM) SVC (Sensorless Vector Control)	
	Control Setting	MODBUS, Analog, Digital, PID, Pulse	
	Communication	MODBUS RTU RS-485	
	Keypad	Film Keypad: <4kW (5HP) Removable: ≥4kW (5HP)	Removable: All power range
Input	Analog Inputs	Total 2: 1 input 0-10V, 0-20mA 1 input 0-10V	Total 3: 2 inputs 0-10V, 0-20mA 1 input 0-10V
	Digital Inputs	Total 5: 4 inputs 1kHz 1 input 50kHz	Total 9: 8 inputs 1kHz 1 input 50kHz
Output	Analog Outputs	Up to 2: 1 output 0-10V, 0-20mA ≤2.2kW/3HP, (2nd output available from >2.2kW/3HP)	2 outputs 0-10V, 0-20mA
	Digital Outputs	1 output sink/source	Total 2: 1 output sink/source, 1 output 50kHz
Features	Dynamic Braking Unit	Built-in (≤37kW/50HP)	
		Optional (>37kW/50HP)	
	EMC	Built-in C3 (≥4kW/5HP), Comply with IEC/EN 61800-3	
		Optional C3 (<4kW/5HP), Comply with IEC/EN 61800-3	
		Optional C2, Comply with IEC/EN 61800-3	
General	Operating Temperature	(-10)°C/14°F – 50°C/122°F (de-rated by 1% for every 1°C/2°F above 40°C/104°F)	
	Altitude	2000m/6600 ft (de-rated by 1% for every additional 100m/330ft above 1000m/3300ft)	
	Enclosure Rating	IP20	
	Mounting Options	Wall and Rail (≤2.2kW/3HP)	Wall, Flange
		Wall and Flange (>2.2kW/3HP)	
	Cooling	Air-cooling	
	Safe Torque Off	√	×
Compliance	CE, TÜV-SÜD Safety Mark, UL and cUL*	CE, UL and cUL	

* 0.4-11kw Drives are UL and cUL certified and support 480Vac

VFD Models



POWER (KW/HP)	Voltage	Part number	Rated Output current (A)	UL & cUL	Safety (TUV SUD)	Permanent Magnet Control	Extended I/Os
0.4\0.5	1Ph 200-240V	UMI-0004BE-B1	2.5	√	STO	-	-
0.75\1	1Ph 200-240V	UMI-0007BE-B1	4.2	√	STO	-	-
	3Ph 200-240V	UMI-0007CU-B5	4.5	√	-	√	√
	3Ph 380-480V	UMI-0007EE-B1	2.5	√	STO	-	-
	3Ph 380-480V	UMI-0007EU-B5	2.5	√	-	√	√
1.5\2	1Ph 200-240V	UMI-0015BE-B1	7.5	√	STO	-	-
	3Ph 200-240V	UMI-0015CU-B5	7	√	-	√	√
	3Ph 380-480V	UMI-0015EE-B1	4.2	√	STO	-	-
		UMI-0015EU-B5	3.7	√	-	√	√
2.2\3	1Ph 200-240V	UMI-0022BE-B1	10	√	STO	-	-
	3Ph 200-240V	UMI-0022CU-B5	10	√	-	√	√
	3Ph 380-480V	UMI-0022EE-B1	5.5	√	STO	-	-
		UMI-0022EU-B5	5	√	-	√	√
4\5	3Ph 200-240V	UMI-0040CU-B5	16	√	-	√	√
	3Ph 380-480V	UMI-0040EE-B1	9.5	√	STO	-	-
		UMI-0040EU-B5	9.5	√	-	√	√
5.5\7.5	3Ph 200-240V	UMI-0055CU-B5	21	√	-	√	√
	3Ph 380-480V	UMI-0055EE-B1	14	√	STO	-	-
		UMI-0055EU-B5	14	√	-	√	√
		UMI-0055EU-B5	14	√	-	√	√
7.5\10	3Ph 200-240V	UMI-0075CU-B5	30	√	-	√	√
	3Ph 380-480V	UMI-0075EE-B1	18.5	√	STO	-	-
		UMI-0075EU-B5	18.5	-	-	√	√



POWER (KW/HP)	Voltage	Part number	Rated Output current (A)	UL & cUL	Safety (TUV SUD)	Permanent Magnet Control	Extended I/Os
11\15	3Ph 200-240V	UMI-0110CU-B5	42	√	-	√	√
	3Ph 380-480V	UMI-0110EE-B1	25	√	STO	-	-
		UMI-0110EU-B5	25	√	-	-	-
15\20	3Ph 200-240V	UMI-0150CU-B5	55	√	-	√	√
	3Ph 380-440V	UMI-0150EE-B1	32	-	STO	-	-
	3Ph 380-480V	UMI-0150EU-B5	32	√	-	√	√
18.5\25	3Ph 200-240V	UMI-0185CU-B5	70	√	-	√	√
	3Ph 380-440V	UMI-0185EE-B1	38	-	STO	-	-
	3Ph 380-480V	UMI-0185EU-B5	38	√	-	√	√
22\30	3Ph 200-240V	UMI-0220CU-B5	80	√	-	√	√
	3Ph 380-440V	UMI-0220EE-B1	45	-	STO	-	-
	3Ph 380-480V	UMI-0220EU-B5	45	√	-	√	√
30\40	3Ph 200-240V	UMI-0300CU-B5	110	√	-	√	√
	3Ph 380-440V	UMI-0300EE-B1	60	-	STO	-	-
	3Ph 380-480V	UMI-0300EU-B5	60	√	-	√	√
37\50	3Ph 200-240V	UMI-0370CU-B5	130	√	-	√	√
	3Ph 380-440V	UMI-0370EE-B1	75	-	STO	-	-
	3Ph 380-480V	UMI-0370EU-B5	75	√	-	√	√
45\60	3Ph 200-240V	UMI-0450CU-B5	160	√	-	√	√
	3Ph 380-440V	UMI-0450EE-B1	92	-	STO	-	-
	3Ph 380-480V	UMI-0450EU-B5	92	√	-	√	√
55\75	3Ph 200-240V	UMI-0550CU-B5	200	√	-	√	√
	3Ph 380-440V	UMI-0550EE-B1	115	-	STO	-	-
	3Ph 380-480V	UMI-0550EU-B5	115	√	-	√	√
75\100	3Ph 380-440V	UMI-0750EE-B1	150	-	STO	-	-
	3Ph 380-480V	UMI-0750EU-B5	150	√	-	√	√
90\120	3Ph 380-440V	UMI-0900EE-B1	180	-	STO	-	-
	3Ph 380-480V	UMI-0900EU-B5	180	√	-	√	√
110\150	3Ph 380-440V	UMI-1100EE-B1	215	-	STO	-	-
	3Ph 380-480V	UMI-1100EU-B5	215	√	-	√	√

UMI- B1: Drive Dimensions

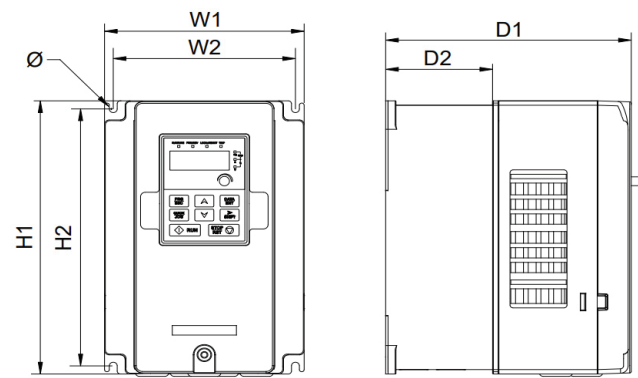

UMI- B5: Drive Dimensions

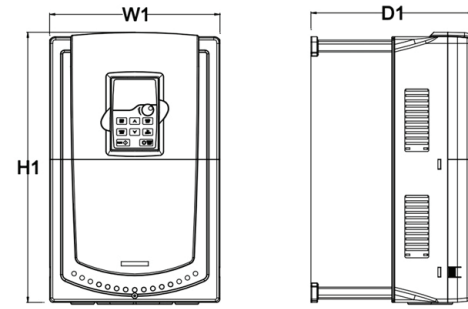

Model	W1	H1	D1	D2	Weight (kg)	
UMI-0004BE-B1	80	160	123.5	120.3	0.9	
UMI-0007BE-B1						
UMI-0004BU-B1						
UMI-0007BU-B1						
UMI-0015BE-B1		185	140.5	137.3	1.2	
UMI-0022BE-B1						
UMI-0015BU-B1						
UMI-0004CU-B1						
UMI-0007CU-B1						
UMI-0022BU-B1						
UMI-0007EE-B1						1
UMI-0015EE-B1						
UMI-0022EE-B1						
UMI-0007EU-B1						
UMI-0015EU-B1						
UMI-0022EU-B1						
UMI-0040EE-B1	146	256	167	84.5	3.1	
UMI-0055EE-B1						
UMI-0075EE-B1	170	320	196.3	113	5.6	
UMI-0110EE-B1					5.9	
UMI-0150EE-B1						
UMI-0185EE-B1	200	340.6	184.3	104.5	9	
UMI-0220EE-B1						
UMI-0300EE-B1	250	400	202	123.5	15.5	
UMI-0370EE-B1						
UMI-0450EE-B1	282	560	238	138	25	
UMI-0550EE-B1						
UMI-0750EE-B1						
UMI-0900EE-B1	338	554	329	-	45	
UMI-1100EE-B1						

Model	W1	H1	D1	Weight (kg)
UMI-0007CU-B5	126	196	175	1.2
UMI-0015EU-B5				2.5
UMI-0022EU-B5				2.5
UMI-0015CU-B5	146	263	181	4
UMI-0022CU-B5				
UMI-0040EU-B5				
UMI-0055EU-B5	170	332	216	7
UMI-0040CU-B5				
UMI-0055CU-B5				
UMI-0750EU-B5	230	342	216	8
UMI-0110EU-B5				
UMI-0075CU-B5				
UMI-0150EU-B5	255	407	245	10
UMI-0185EU-B5				
UMI-0110CU-B5				
UMI-0150CU-B5	270	555	325	30
UMI-0220EU-B5				
UMI-0300EU-B5				
UMI-0185CU-B5	325	680	365	47
UMI-0220CU-B5				
UMI-0300CU-B5				
UMI-0370EU-B5	325	680	365	47
UMI-0450EU-B5				
UMI-0550EU-B5				
UMI-0370CU-B5	325	680	365	47
UMI-0450CU-B5				
UMI-0550CU-B5				
UMI-0750EU-B5	325	680	365	47
UMI-0900EU-B5				
UMI-1100EU-B5				

Optional Parts



External Keypads

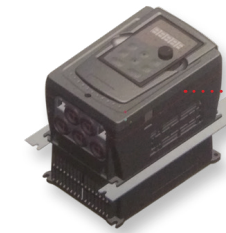

Flange Mounting Plates



Braking Resistors

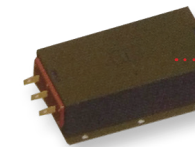

C3 Input Filters
C2 Filters

Product Designation Key

UMI - 0022 E U - B1
① ② ③ ④ ⑤

No.	Key	Description
①	Product Line	Unitronics Motion Inverters
②	Power Range	0004:400W/0.5HP 0022:2.2kW/3HP
③	Power Rating	B: 1PH 200V-240V C: 3PH 200V-240V E: 3PH 380V-440V/480V
④	Certification	*U - UL Certified E - TÜV-SÜD Certified ,UL*
⑤	Product series	B1 / B5

* 0.4-11kw Drives are UL and cUL certified and support 480Vac

UniCloud

Complete No-Code IIoT Cloud Platform

Designed specifically for OEMs & Machine Builders



'Go Cloud' Under 30 Minutes

Build a working, live, fully-functional dashboard that harvests, analyzes, and displays data—in less than 30 minutes.

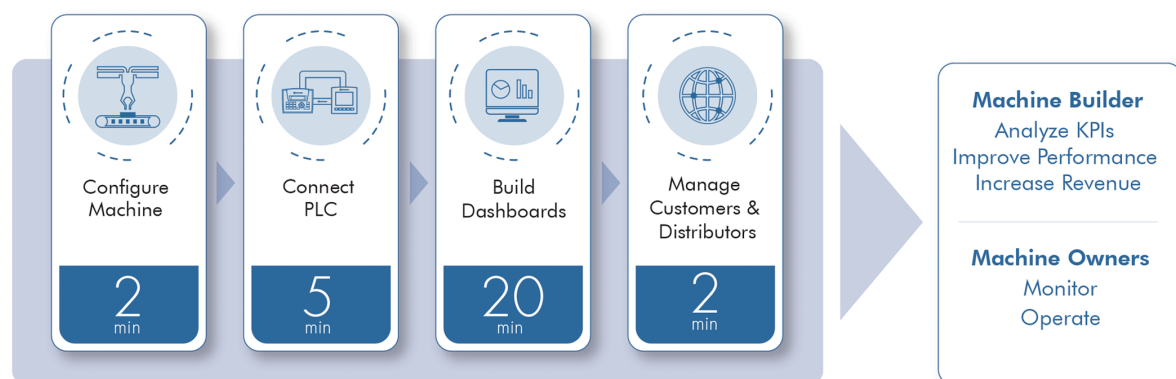

Use Your Data To Increase Profits

Gain full control of your data, without relying on programmers or IT/Cloud professionals.

UniCloud is that simple: Do-It-Yourself

- Monitor & improve processes
- Reduce operational and maintenance costs
- Predict failures and minimize unplanned slowdowns & shutdowns
- Integrate—easily—with any device over MODBUS protocol



SECURED

UniCloud's architecture is designed with multilayered security at its backbone.



NO CODE

No programming, IT knowledge, or Cloud expertise needed. UniCloud has it all—built-in cloud infrastructure, easy user interfaces & incredible functionality.



INCREASE PROFIT

Monitor & improve processes, while reducing operational and maintenance costs. Predict failures, minimize unplanned slowdowns and shutdowns.



CUSTOMIZE

Display data your way—customize data display with UniCloud's Wizards.

Enjoy a 3-month free trial
Log into the UniCloud website - try it yourself:
www.unitronics.cloud



Fast. Easy. Cost-effective

Unitronics' One Integrated Solution for Control & Automation offers the best of two worlds: great flexibility in component selection, together with the simplicity of an all-inclusive, time-saving, single-vendor solution.

“ I would like to again mention that this was the first time that I have ever written a control or motion control program – but UniLogic is a great programming platform. The environment for Servo operation and programming is intuitive and easy to use. We were concerned that this project would require a great deal of time – but Unitronics really has made Servo motion simple. ”

Yakir Cohen, Mechanical Engineer at Stratasys

“ The simplicity of controlling the VFDs over communication is a winner, for sure. Can't understand why anyone would work differently. ”

Edi Gulko, Application engineer

“ I am happy that I made the change because of the versatility of the software and equipment, service, support, and the lack of licensing costs. It is also very refreshing to me that I have their full support even though I am a small customer. The entire team at Unitronics has been awesome. Thanks to all for the support of our program and venture. ”

Nils Anderson, an instructor in the Robotics/Mechatronics program at ONC BOCES

- AC Servo Drive & Motor
- Full line of VFDs
- Complete range of controllers
- All-in-One programming software
- IIoT cloud platform: UniCloud



To Find Your Local Distributor, Visit Our Website:
UnitronicsPLC.com → Where To Buy

The information in this document reflects products at the date of printing. Unitronics reserves the right, subject to all applicable laws, at any time, at its sole discretion, and without notice, to discontinue or change the features, designs, materials and other specifications of its products, and to either permanently or temporarily withdraw any of the foregoing from the market. All information in this document is provided „as is“ without warranty of any kind, either expressed or implied, including but not limited to any implied warranties of merchantability, fitness for a particular purpose, or non-infringement. Unitronics assumes no responsibility for errors or omissions in the information presented in this document. In no event shall Unitronics be liable for any special, incidental, indirect or consequential damages of any kind, or any damages what so ever arising out of or in connection with the use or performance of this information. The trade names, trademarks, logos and service marks presented in this document, including their design, are the property of Unitronics (1989) (R“G) Ltd. or other third parties and you are not permitted to use them without the prior written consent of Unitronics or such third party as may own them



International Headquarters: P.O.B. 300, Ben Gurion Airport 7019900, Israel. Tel: +972 3 977 88 88, global.sales@unitronics.com