



EN Operating instructions.pages 1 to 8
Original

Content

1 About this document

1.1 Function. 1

1.2 Target group: authorised qualified personnel 1

1.3 Explanation of the symbols used. 1

1.4 Appropriate use. 1

1.5 General safety instructions 1

1.6 Warning about misuse. 2

1.7 Exclusion of liability. 2

2 Product description

2.1 Ordering code 2

2.2 Special versions 2

2.3 Comprehensive quality insurance to 2006/42/EC 2

2.4 Purpose. 2

2.5 Technical Data. 2

2.6 Safety classification of the interlocking function 3

2.7 Safety classification of the guard locking function. 3

3 Assembly

3.1 General mounting instructions. 4

3.2 Dimensions 4

3.3 Retrofit kit for Manual release/Emergency exit 4

4 Electrical connection

4.1 General information for electrical connection 5

5 Functions and configuration

5.1 Mode of operation of the safety outputs 5

5.2 Magnet control. 5

5.3 Configuration of the safety monitor 5

5.4 Programming the slave address 5

5.5 Status signal "safety release" 5

5.6 Actuator teaching / actuator detection. 5

6 Diagnostic

6.1 LED indications 6

6.2 Error / Error warning 6

6.3 Diagnostic information. 6

6.4 Diagnostic signal periphery error (FID) 7

6.5 Locking/unlocking of the solenoid interlock blocked 7

6.6 Read-out of the parameter ports 7

7 Set-up and maintenance

7.1 Functional testing 7

7.2 Maintenance 7

8 Disassembly and disposal

8.1 Disassembly 7

8.2 Disposal. 7

9 EU Declaration of conformity

1. About this document

1.1 Function

This operating instructions manual provides all the information you need for the mounting, set-up and commissioning to ensure the safe operation and disassembly of the safety switchgear. The operating instructions must be available in a legible condition and a complete version in the vicinity of the device.

1.2 Target group: authorised qualified personnel

All operations described in this operating instructions manual must be carried out by trained specialist personnel, authorised by the plant operator only.

Please make sure that you have read and understood these operating instructions and that you know all applicable legislations regarding occupational safety and accident prevention prior to installation and putting the component into operation.

The machine builder must carefully select the harmonised standards to be complied with as well as other technical specifications for the selection, mounting and integration of the components.

1.3 Explanation of the symbols used



Information, hint, note:

This symbol indicates useful additional information.



Caution: Failure to comply with this warning notice could lead to failures or malfunctions.

Warning: Failure to comply with this warning notice could lead to physical injury and/or damage to the machine.

1.4 Appropriate use

The products described in these operating instructions are developed to execute safety-related functions as part of an entire plant or machine. It is the responsibility of the manufacturer of a machine or plant to ensure the correct functionality of the entire machine or plant.

The safety switchgear must be exclusively used in accordance with the versions listed below or for the applications authorised by the manufacturer. Detailed information regarding the range of applications can be found in the chapter "Product description".

1.5 General safety instructions

The user must observe the safety instructions in this operating instructions manual, the country specific installation standards as well as all prevailing safety regulations and accident prevention rules.



Further technical information can be found in the Schmersal catalogues or in the online catalogue on the Internet: products.schmersal.com.

The information contained in this operating instructions manual is provided without liability and is subject to technical modifications.

There are no residual risks, provided that the safety instructions as well as the instructions regarding mounting, commissioning, operation and maintenance are observed.

1.6 Warning about misuse



In case of improper use or manipulation of the safety switchgear, personal hazards or damages to machinery or plant components cannot be excluded. The relevant requirements of the standard ISO 14119 must be observed.

1.7 Exclusion of liability

We shall accept no liability for damages and malfunctions resulting from defective mounting or failure to comply with this operating instructions manual. The manufacturer shall accept no liability for damages resulting from the use of unauthorised spare parts or accessories.

For safety reasons, invasive work on the device as well as arbitrary repairs, conversions and modifications to the device are strictly forbidden, the manufacturer shall accept no liability for damages resulting from such invasive work, arbitrary repairs, conversions and/or modifications to the device.

2. Product description

2.1 Ordering code

This operating instructions manual applies to the following types:

AZM201^①-②-ST-T-AS-③-P

| No. | Option | Description |
|-----|--------|---|
| ① | Z | Solenoid interlock monitored |
| | B | Actuator monitoring |
| | BZ | Combined actuator/solenoid interlock monitoring |
| ② | | Standard coding |
| | I1 | Individual coding |
| ③ | I2 | Individual coding, re-teaching enabled |
| | A | Power to unlock (spring-operated locking) |
| P | | Power to lock (magnet-operated locking) |
| | | Magnet supply from 24 VDC (U _{AUX}) |

| Actuator | suitable for |
|-------------------|-------------------------------------|
| AZ/AZM201-B1-... | Sliding safety guards |
| AZ/AZM201-B30-... | Hinged safety guards |
| AZ/AZM201-B40-... | Hinged-doors with overlapping folds |



Only if the information described in this operating instructions manual are realised correctly, the safety function and therefore the compliance with the Machinery Directive is maintained.

2.2 Special versions

For special versions, which are not listed in the order code below 2.1, these specifications apply accordingly, provided that they correspond to the standard version.

2.3 Comprehensive quality insurance to 2006/42/EC

Schmersal is a certified company to appendix X of the Machinery Directive. As a result, Schmersal is entitled to autonomously conduct the conformity assessment procedure for the products listed in Appendix IV of the MD without involving a notified body. The prototype test certificates are available upon request or can be downloaded from the Internet at products.schmersal.com.

2.4 Purpose

The non-contact, electronic safety switchgear is designed for application in AS-Interface Safety at Work and is used for monitoring the position and locking of movable safety guards.



The safety switchgears are classified according to ISO 14119 as type 4 interlocking devices. Designs with individual coding are classified as highly coded.

The different variants can be used as safety switch with interlocking function either as solenoid interlock.



If the risk analysis indicates the use of a monitored interlock then a variant with the monitored interlock is to be used, labelled with the symbol.

The actuator monitoring variant (B) is a safety switch with an interlock function for process protection.

The safety function consists of safely switching off the code transfer when the guard system is unlocked or opened and maintaining the safe switched off condition of the safety outputs for as long as the guard system is unlocked or open.



Interlocks with power to lock principle may only be used in special cases after a thorough evaluation of the accident risk, since the safety guard can be opened immediately on failure of the power supply or upon activation of the main switch.

An AS-Interface Safety at Work component functions on the basis of an individual code generator (8 x 4 bit). This safety code is cyclically transmitted over the AS-i network and monitored by a safety monitor.



The user must evaluate and design the safety chain in accordance with the relevant standards and the required safety level.



The entire concept of the control system, in which the safety component is integrated, must be validated to the relevant standards.

2.5 Technical Data

Standards: EN 60947-5-3, ISO 14119, EN 62026-2, EN ISO 13849-1, EN 61508

| | |
|--------------------------------------|--|
| Active principle: | RFID |
| Frequency band: | 125 kHz |
| Transmitter output: | max. -6 dBm |
| Coding level according to ISO 14119: | |
| - I1-version: | high |
| - I2-version: | high |
| - Standard coding version: | low |
| Material of the enclosure: | glass-fibre reinforced thermoplastic, self-extinguishing |
| Maximum switching frequency: | 1 Hz |
| Response time: | ≤ 100 ms |
| Duration of risk: | ≤ 200 ms |
| Time to readiness: | ≤ 4 s |

Mechanical data

| | |
|---|---|
| Connection: | Connector plug M12, 4-pole, A-coded |
| Mechanical life: | ≥ 1,000,000 operations |
| Actuating speed: | ≤ 0.2 m/s |
| Tightening torque for device fixation: | max. 8 Nm |
| Tightening torque for the cover screws: | 0.7 ... 1 Nm (Torx T10) |
| Latching force: | 30 N |
| Holding force F_{max} : | 2,600 N (1,300 N when used with the AZ/AZM201-B30 actuator, for indoor use) |
| Holding force F_{Zh} : | 2,000 N (1,000 N when used with the AZ/AZM201-B30 actuator, for indoor use) |

Environmental conditions

| | |
|---|--------------------------------------|
| Ambient temperature: | -25 °C ... +60 °C |
| Storage and transport temperature: | -25 °C ... +85 °C |
| Relative humidity: | max. 93 %, non condensing, non icing |
| Resistance to shock: | 30 g / 11 ms |
| Resistance to vibration: | 10 ... 150 Hz, Amplitude 0.35 mm |
| Degree of protection: | IP66, IP67 to EN 60529 |
| Installation altitude above sea level: | max. 2,000 m |
| Protection class: | III |
| Insulation values to EN 60664-1: | |
| - Rated insulation voltage U_i : | 32 VDC |
| - Rated impulse withstand voltage U_{imp} : | 0.8 kV |
| - Over-voltage category: | III |
| - Degree of pollution: | 3 |

Electrical data – AS-Interface

| | |
|----------------------------|---|
| AS-i operating voltage: | 26.5 - 31.6 V DC, protection against polarity reversal |
| AS-i power consumption: | ≤ 0.1 A |
| AS-i device insulation: | internal short-circuit proof |
| AS-i specification: | |
| - Version: | V 3.0 |
| - Profile: | S-7.B.F.E |
| AS-i inputs: | |
| - Channel 1: | Data bits DI 0/DI 1 = dynamic code transmission |
| - Channel 2: | Data bits DI 2/DI 3 = dynamic code transmission |
| | Data bits condition static 0 or dynamic code transmission |
| AS-i outputs: | |
| - DO 0: | Magnetically controlled locking |
| - DO 1 ... DO 3: | No function |
| AS-i parameter bits: | |
| - P0: | Door and actuator detected |
| - P1: | Interlock locked |
| - P2: | Auxiliary voltage U_{AUX} in tolerance range ($18 V \leq U_{AUX} \leq 28 V$) |
| - P3: | Device error (FID) |
| Parameter request: | default value parameter request "1111" (0xF) |
| AS-i Input module address: | 0 |
| | - preset to address 0, can be changed through AS-interface bus master or hand-held programming device |

Electrical data - auxiliary voltage (AUX):

| | |
|------------------------------------|---|
| Internal operating voltage U_B : | 24 VDC -15% / +10% reverse polarity-proof (stabilised PELV units) |
| Power consumption: | |
| - Averaged: | < 0.2 A |
| - Peak current: | ≤ 0.5 A / 100 ms |
| Magnet switch-on time: | 100 % |
| Device fuse rating: | ≤ 4 A when used to UL 508 |

LED status display

| | |
|-------------------------------|--|
| green/red LED (AS-i Duo LED): | Supply voltage / Communication error / Slave address = 0 / Peripheral error set / Device error detected / Manipulation protection active |
| red LED: | Internal device error |
| yellow LED: | Device condition (Enabling status) |



Use isolated power supply only. For use in NFPA 79 Applications only. Adapters providing field wiring means are available from the manufacturer. Refer to manufacturers information.



This device complies with part 15 of the FCC Rules and contains licence-exempt transmitter(s)/receiver(s) that comply with Innovation, Science and Economic Development Canada's licence-exempt RSS(s). Operation is subject to the following two conditions:
 (1) This device may not cause harmful interference,
 AND
 (2) this device must accept any interference received, including interference that may cause undesired operation.
 This device complies with the Nerve Stimulation Exposure Limits (ISED SPR-002) for direct touch operations. Changes or modifications not expressly approved by K.A. Schmersal GmbH & Co. KG could void the user's authority to operate the equipment.

2.6 Safety classification of the interlocking function

| | |
|-------------------|---------------------------------|
| Standards: | EN ISO 13849-1, EN 61508 |
| PL: | up to e |
| Control Category: | 4 |
| PFH: | ≤ 1.81 x 10 ⁻⁹ / h |
| PFDAvg: | ≤ 1.59 x 10 ⁻⁴ |
| SIL: | suitable for SIL 3 applications |
| Mission time: | 20 years |

2.7 Safety classification of the guard locking function

If the device is used as an interlock for personal safety, a safety classification of the guard locking function is required.

When classifying the interlock function, a distinction must be made between monitoring of the interlock function (locking function) and controlling the unlocking function.

The following safety classification of the unlocking function is based on the application of the principle of safety energy disconnection for the solenoid supply.



The safety classification of the unlocking function is only valid for devices with monitored guard locking function, in power to unlock version and with solenoid supply from 24 VDC (AUX) (see ordering code).

A fault exclusion for the guard locking function can be assumed by an external safety energy disconnection.

In this case, the guard locking function does not have an effect on the failure probability of the unlock function.

The safety level of the unlock function is determined exclusively by the external safety power shutdown.

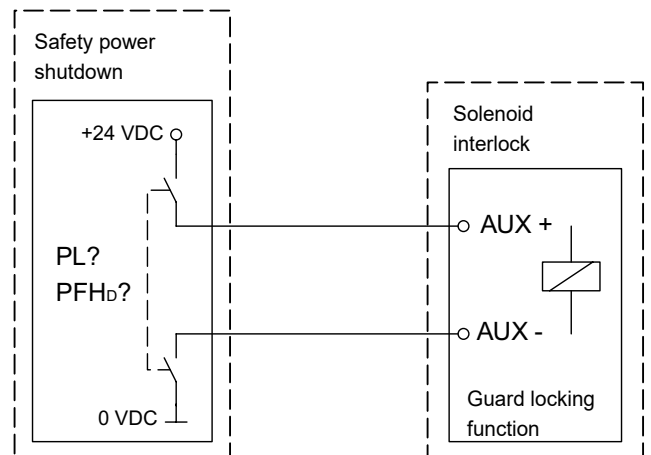



Fault exclusion with regard to wiring routing must be observed.



If for a certain application the power to unlock version of a solenoid interlock cannot be used, for this exception an interlock with power to lock can be used if additional safety measure need to be realised that have an equivalent safety level.

3. Assembly

3.1 General mounting instructions



Please observe the relevant requirements of the standards ISO 12100, ISO 14119 and ISO 14120.

To mount the solenoid interlock, two mounting holes for M6 screws with washers (washers included in delivery) are provided in the device. The solenoid interlock must not be used as an end stop. Any mounting position. The mounting position however must be chosen so that the ingress of dirt and soiling in the used opening is avoided. The unused actuator opening must be sealed by means of the dust-proof flap (included in delivery).

Minimum distance between two solenoid interlocks as well as to other systems with same frequency (125 kHz): 100 mm.

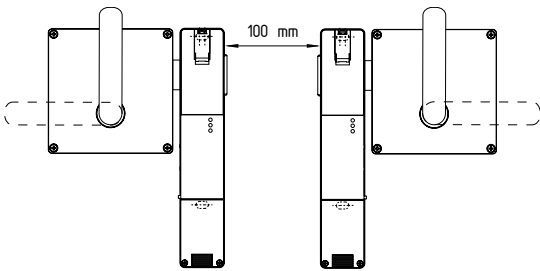

Mounting of the actuator

Refer to the mounting instructions manual for the corresponding actuator.



The actuator must be permanently fitted to the safety guards and protected against displacement by suitable measures (tamperproof screws, gluing, drilling of the screw heads).

Manual release

For the machine set-up, the solenoid interlock can be unlocked in a de-energised condition. After opening of the plastic flap "A" (refer to image "Dimensions"), the triangular key must be turned clockwise to bring the blocking bolt in unlocking condition. The normal locking function is only restored after the triangular key has been returned to its original position.



Caution: do not turn beyond the latching point, maximum tightening torque: 1.3 Nm.

After being put into operation, the manual release must be secured by closing the plastic flap "A" and affixing the seal, which is included in delivery.

Component ready for operation

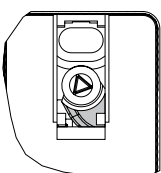

Component not ready for operation

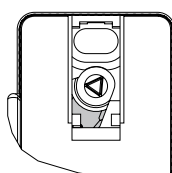

3.2 Dimensions

All measurements in mm.

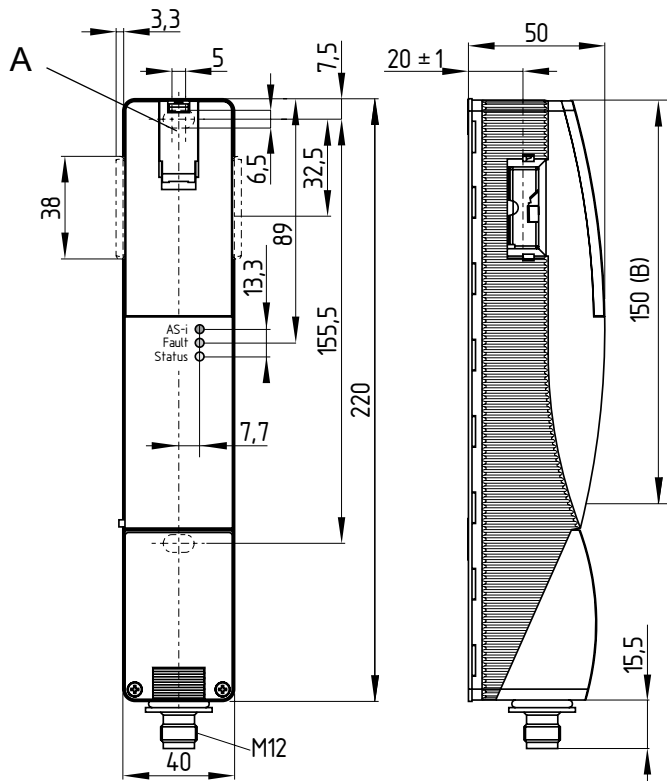

Key

A: Manual release
B: Active RFID area



Metal parts and magnetic fields in the lateral RFID area of the solenoid interlock and the actuator can influence the switching distance or lead to malfunctions.

3.3 Retrofit kit for Manual release/Emergency exit

The retrofit kit is used for subsequent functional expansion of the solenoid interlock.

| | Designation | Ordering code |
|-------------------|-------------|---------------|
| Emergency release | RF-AZM200-N | 103003543 |
| Emergency Exit | RF-AZM200-T | 103004966 |

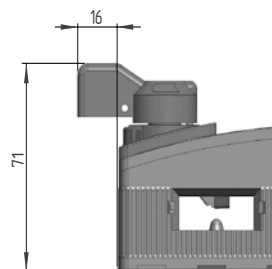

4. Electrical connection

4.1 General information for electrical connection



The electrical connection may only be carried out by authorised personnel in a de-energised condition.

The connection to the AS-Interface system is realised through an M12 connector. The M12 x 1 connector has an A-coding. The wiring configuration of the M12 connector is defined as follows (to EN 62026-2):

Pin assignment M12 connector

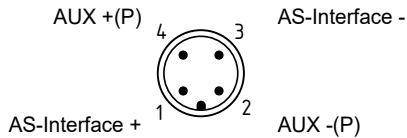

5. Functions and configuration

5.1 Mode of operation of the safety outputs

AZM201Z-ST-T-AS

The safety outputs of the AS-i safety monitor are enabled, when the following conditions are met:

- guard door detected
- the actuator is inserted
- the solenoid interlock is locked

AZM201B-ST-T-AS

The safety outputs of the AS-i safety monitor are enabled, when the following conditions are met:

- guard door detected
- the actuator is inserted

AZM201BZ-ST-T-AS

The safety outputs of the AS-i safety monitor are only activated, when both AS-i half-codes are enabled.

Half-code 1 (AS-i SaW bit 0,1) is enabled, when:

- guard door detected
- the actuator is inserted

The solenoid interlock now can be locked!

Half-code 2 (AS-i SaW bit 2,3) is enabled, when:

- the solenoid interlock is additionally locked.

5.2 Magnet control

The control system with the AS-Interface Master can lock and unlock the solenoid interlock through the output bit 0 of the addressed AS-i slave AZM201-AS.

In the power to lock variant of the AZM201-AS, the functional set of output bit 0 will cause the solenoid interlock to be locked.

In the power to unlock variant of the AZM201-AS, the functional set of output bit 0 will cause the solenoid interlock to be unlocked.

5.3 Configuration of the safety monitor

The AZM201-AS can be configured in the ASIMON configuration software with the following monitoring module (also refer to the ASIMON manual).

Double channel dependent

Suitable for: AZM201Z-ST-T-AS, AZM201B-ST-T-AS, AZM201BZ-ST-T-AS

- Synchronisation time typically: 0.1 s;
for AZM201BZ-ST-T-AS infinite (∞)
- Optionally with startup test
- Optional with local acknowledge

When the AZM201BZ-ST-T-AS is used together with this monitoring device for conducting the start-up test prior to every restart, the safety guard must be opened.

Double channel conditionally dependent

Suitable for: AZM201BZ-ST-T-AS

- Independent: In-1

As long as the actuator remains inserted, the safety guard can be relocked at any time, in which case the safety outputs are reactivated. The safety guard must not be opened.



The configuration of the safety monitor must be tested and confirmed by a qualified and authorised safety expert/safety engineer.

5.4 Programming the slave address

The slave address is programmed through the M12 connector. Any address from 1 to 31 can be set by means of the AS-i bus master or a hand-held programming device.

5.5 Status signal "safety release"

The "safety release" status signal from a Safety at Work slave can be cyclically queried by the control system through the AS-i master. To that effect, the 4 input bits with the varying SaW code of a Safety at Work slave are evaluated through an OR operation with 4 inputs in the control system.

5.6 Actuator teaching / actuator detection

Solenoid interlocks with standard coding are ready to use upon delivery.

Individually coded solenoid interlocks and actuators will require the following "teach-in" procedure:

1. Switch the solenoid interlock's voltage supply off and back on.
2. Introduce the actuator in the detection range. The teach-in is signaled to the solenoid interlock, the red LED illuminates and the yellow LED flashes (1 Hz).
3. After 10 seconds, brief yellow cyclic flashes (5 Hz) request the switch-off of the operating voltage of the solenoid interlock. (If the voltage is not switched off within 5 minutes, the solenoid interlock cancels the "teach-in" procedure and signals a false actuator by 5 red flashes).
4. After the operating voltage is switched back on, the actuator must be detected once more in order to activate the taught actuator code. In this way, the activated code is definitively saved!

For ordering suffix -I1, the executed allocation of safety interlock and actuator is irreversible.

For ordering suffix -I2, the "teach-in" procedure for a new actuator can be repeated an unlimited number of times. When a new actuator is taught, the code, which was applicable until the moment, becomes invalid. Subsequent to that, an enabling inhibit will be active for ten minutes, thus providing for an increased protection against tampering. The AS-i Duo LED will flash red/green until the expiration of the time of the enabling inhibit and the detection of the new actuator. In case of power failure during the lapse of time, the 10-minutes tampering protection time will restart.

6. Diagnostic

6.1 LED indications

The solenoid interlock signals the operational state as well as errors through three coloured LED's installed on the front side of the device.

The LEDs have the following meaning (in accordance with EN 62026-2)

| | |
|----------------------------------|--|
| LED red/green (AS-i Duo LED): | AS-Interface supply voltage / AS-Interface communication error / |
| LED red/green (AS-i Duo LED): | Slave address = 0 / Periphery error set / Device error detected / Manipulation protection time active |
| LED red (Fault): | Device error (see table 2) |
| LED yellow (Status): | Device status/enabling status (actuator inserted/interlock locked) |

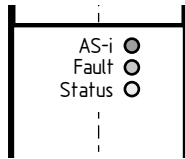

6.2 Error / Error warning

Errors, which no longer guarantee the safe functionality of the AZM201-AS safety switchgear, cause the safety enabling to be switched off and are signalled through a flashing pattern of the red LED (see table 2).

After fault rectification, the error message can be reset by opening and closing the relevant guard door.

The safety outputs of the safety monitor can be switched back on, thus enabling the machine.

With an excess temperature in the device the system is safely switched off only after 30 mins. as the safe functioning of the AZM201-AS is guaranteed.

The fault warning is via the permanent port P3 and the FID-Bit.

These advanced fault warnings can be used to control the process switch off.

6.3 Diagnostic information

Table 1: Diagnostic information of the safety switchgear AZM201-AS

The safety switch signals the switching condition as well as malfunctions via three coloured LEDs installed on the device.

| System condition | Solenoid control (DO 0) | | LED indications | | | Fault diagnostic | | | | | Authorised operation |
|--|-------------------------|-----------------|------------------------|----------------------------|----------------------------|------------------|----|----|----|----|---|
| | Power to lock | Power to unlock | red/green AS-i duo-LED | red Error | yellow Status | FID-Bit | P3 | P2 | P1 | P0 | AS-i SaW-Code (DI 0 ... DI 3) |
| Safety guard open | 0 | 1 | green | Off | Off | 0 | 0 | X | 0 | 0 | static 0 |
| Guard system closed and actuator inserted. | 0 | 1 | green | Off | Flashes | 0 | 0 | X | 0 | 1 | AZM201B-AS: dynamic AZM201Z-AS: static 0 AZM201BZ-AS: DI 0/DI 1 dynamic DI 2/DI 3 static 0 |
| Solenoid interlock locked | 1 | 0 | green | Off | on | 0 | 0 | X | 1 | 1 | dynamically |
| Actuator teach-in process (1 variants only) | 0/1 | 0/1 | red-green flashing | on | Flashes | 1 | 1 | X | 0 | 0 | static 0 |
| Manipulation protection active (12 variant only) | 0/1 | 0/1 | red-green flashing | Off | Off | 1 | 0 | X | 0 | 0 | static 0 |
| Locking / unlocking blocked | 0/1 | 0/1 | red-green flashing | Off | depending on the condition | 1 | 1 | X | X | X | depending on the condition |
| AUX power switched off | 0/1 | 0/1 | green | Off | depending on the condition | 0 | X | 0 | X | X | depending on the condition |
| Device fault detected | 0/1 | 0/1 | red-green flashing | Flashes ¹⁾ | Off | 1 | 1 | X | X | X | static 0 |
| AS-i error: Slave address = 0 or communication error | 0/1 | 0/1 | red | depending on the condition | | – | – | – | – | – | static 0 |

¹⁾ refer to flash code

Table 2: Error messages / flash codes red LED

| Flash codes (red) | Designation | Autonomous switch-off after | Error cause |
|-----------------------|----------------------------|-----------------------------|---|
| 4 flashes | Excess device temperature | 30 min | Internal excess temperature T > 90 C (FID) |
| 5 flashes | Actuator fault | 0 min | Wrong or defective actuator (FID) |
| 6 flashes | Error actuator combination | 0 min | Latch breakage or attempt at manipulation (FID) |
| Continuous red signal | Internal error | 0 min | Device defective (FID) |

6.4 Diagnostic signal periphery error (FID)

All error messages of the safety switchgear are also transmitted as a "periphery error" to the control system through the AS-i master. A "periphery error" (FID input of the AS-i chip) is signaled by the alternating red and green flashing of the AS-i duo LED on the AS-i device.

The periphery error is also set when the manipulation protection time with the teach-in process of a new actuator elapses.

6.5 Locking/unlocking of the solenoid interlock blocked

This error is transmitted, when the solenoid interlock no longer can be correctly locked or unlocked.

The causes for this error can be a safety door not correctly closed, the actuator is deformed, tension on the actuator, the manual release is not correctly reset or the auxiliary voltage is missing.

6.6 Read-out of the parameter ports

The parameter port P0 to P3 of an AS-i slave can be read out through the control interface of the AS-i master (see component description) by means of the "Write parameter" instruction (with hexadecimal value F). This (non-safe) diagnostic information from the reflected parameters or the answer to a "Write parameter instruction" can be used by the user for diagnostic purposes or for the control programme.

Diagnostic information (P0 ... P3)

| Parameter bit | Condition = 1 |
|---------------|---|
| 0 | Door closed AND actuator inserted. |
| 1 | Solenoid interlock locked |
| 2 | Auxiliary voltage U_{AUX} for magnet in tolerance range ($18\text{ V} \leq U_{AUX} \leq 28\text{ V}$) |
| 3 | Internal device error detected (FID) |

7. Set-up and maintenance

7.1 Functional testing

The safety function of the safety components must be tested. The following conditions must be previously checked and met:

1. Fitting of the solenoid interlock and the actuator.
2. Check max. axial misalignment of actuator and solenoid interlock.
3. Fitting and integrity of the cable connections.
4. Check the switch enclosure for damage.

7.2 Maintenance

In the case of correct installation and adequate use, the safety switchgear features maintenance-free functionality.

A regular visual inspection and functional test, including the following steps, is recommended:

- Check for a secure installation of the actuator and the solenoid interlock
- Check max. axial misalignment of actuator and solenoid interlock.
- Fitting and integrity of the cable connections.
- Check the switch enclosure for damages
- Remove particles of dust and soiling.



Adequate measures must be taken to ensure protection against tampering either to prevent tampering of the safety guard, for instance by means of replacement actuators.

Damaged or defective components must be replaced.

8. Disassembly and disposal

8.1 Disassembly

The safety switchgear must be disassembled in a de-energised condition only.

8.2 Disposal

The safety switchgear must be disposed of in an appropriate manner in accordance with the national prescriptions and legislations.

9. EU Declaration of conformity

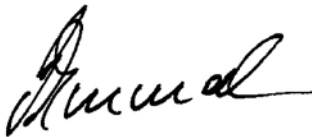
| EU Declaration of conformity | |  SCHMERSAL |
|--|---|--|
| Original | K.A. Schmersal GmbH & Co. KG Möddinghofe 30 42279 Wuppertal Germany Internet: www.schmersal.com | |
| We hereby certify that the hereafter described components both in their basic design and construction conform to the applicable European Directives. | | |
| Name of the component: | AZM201-AS | |
| Type: | See ordering code | |
| Description of the component: | Interlocking device with electromagnetic interlock for safety functions with integrated AS-i Safety at Work | |
| Relevant Directives: | Machinery Directive | 2006/42/EC |
| | RED-Directive | 2014/53/EU |
| | RoHS-Directive | 2011/65/EU |
| Applied standards: | EN 60947-5-3:2013 ISO 14119:2013 EN 300 330 V2.1.1:2017 EN ISO 13849-1:2015 EN 61508 parts 1-7:2010 | |
| Notified body for the prototype test: | TÜV Rheinland Industrie Service GmbH Am Grauen Stein, 51105 Köln ID n°: 0035 | |
| EC-prototype test certificate: | 01/205/5608.00/17 | |
| Person authorised for the compilation of the technical documentation: | Oliver Wacker Möddinghofe 30 42279 Wuppertal | |
| Place and date of issue: | Wuppertal, 21. May 2021 | |
| |  | |
| | Authorised signature Philip Schmersal Managing Director | |

AZM201-AS-B-EN



The currently valid declaration of conformity can be downloaded from the internet at products.schmersal.com.



K.A. Schmersal GmbH & Co. KG
Möddinghofe 30, 42279 Wuppertal
Germany

Phone: +49 202 6474-0
Telefax: +49 202 6474-100
E-Mail: info@schmersal.com
Internet: www.schmersal.com